



Disney

43229





FR
**DONNEZ
OU
RECYCLEZ**



ASSOCIATION

OU



MAGASIN

OU



DÉCHÈTERIE

Adresses sur quefairedemesdechets.fr



LEGO.com/sustainable-packaging

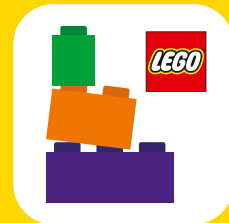

BUILDER



Apple and the Apple logo are trademarks of Apple Inc., registered in the U.S. and other countries and regions. App Store is a service mark of Apple Inc. Google Play and the Google Play logo are trademarks of Google LLC. Tencent and the Tencent logo are trademarks of Tencent Inc.

Q LEGO.com/devicecheck

EN Ask parents' permission before going online | DE Eltern um Erlaubnis bitten, bevor du online gehst | FR Demande l'autorisation d'un parent avant d'aller en ligne | IT Chiedi il permesso ai tuoi genitori prima di andare online | ES Pídeles permiso a tus papás antes de conectarte a Internet | PT Peça autorização aos pais antes de acederes online | ZH 上网前应先征得父母的同意 | PL Poproś rodziców o zgodę, zanim wejdziesz do Internetu | CS Než půjdeš na internet, požádej rodiče o svolení | SK Skôr než půjdeš na internet, vypýtaj si povolenie od rodičov | HU Kérj szülői engedélyt, mielőtt online csatlakoznál! | RO Cere permisiunea părinților înainte de a te conecta online | BG Поискайте разрешение от родител, преди да влезете онлайн | LV Pirms došanās tiešsaistē palūdz atļauju vecākiem | ET Enne Interneti kasutamist küsi vanematelt luba | LT Prieš prisijungdami prie interneto, atsilkauskite tėvų

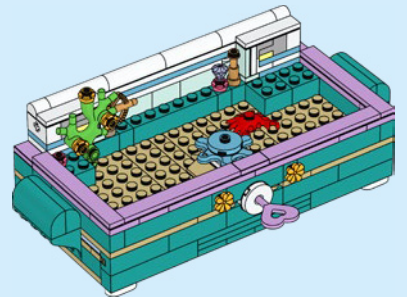
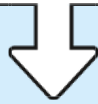
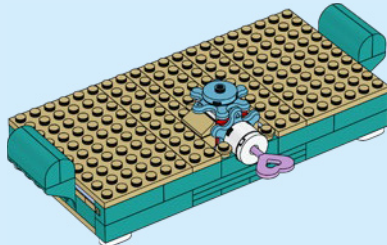
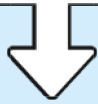
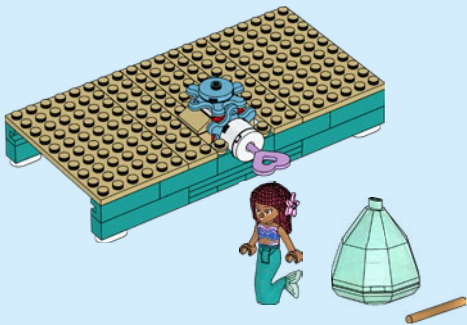
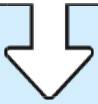

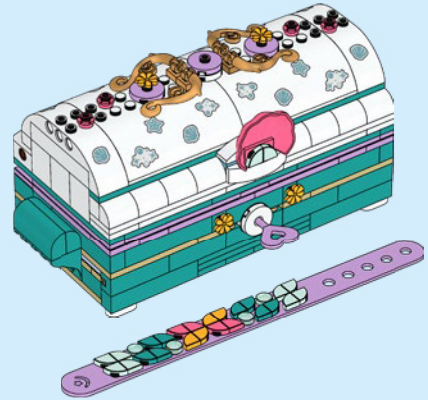
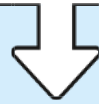
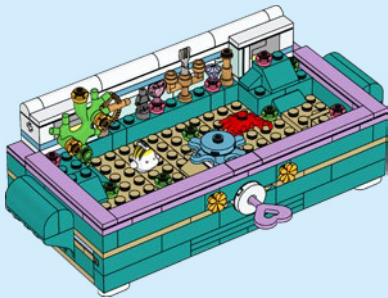
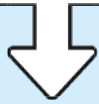

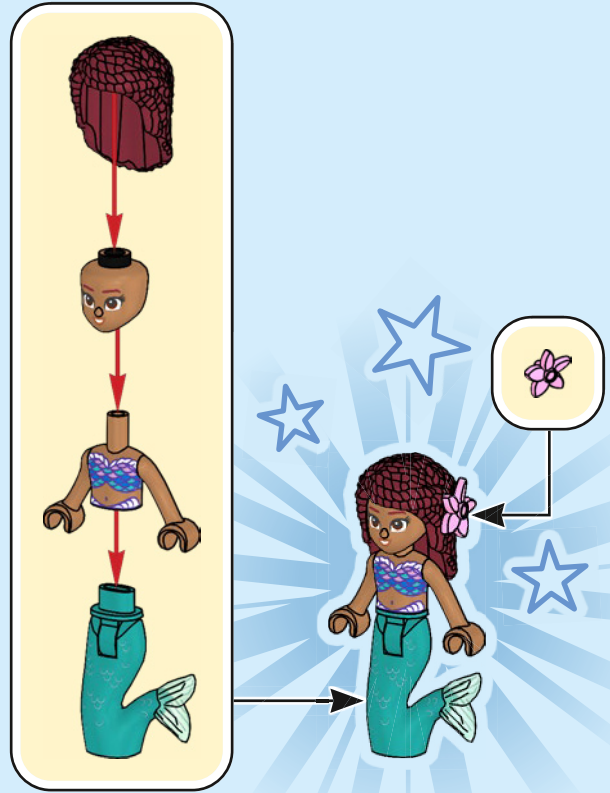

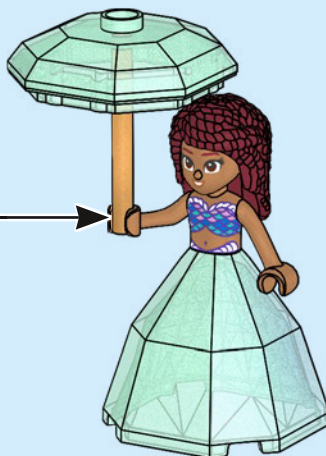
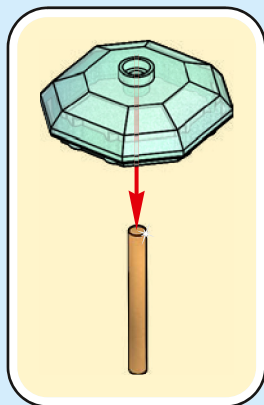
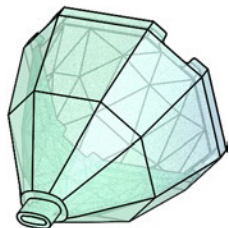

1

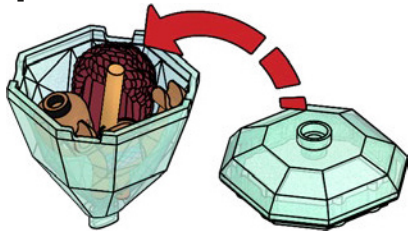

2

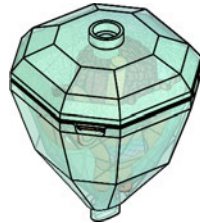

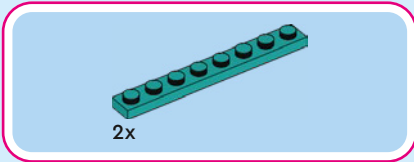
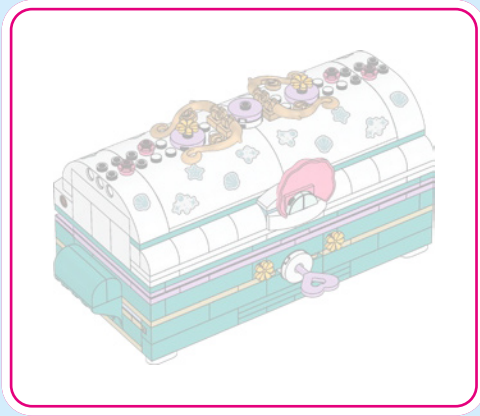

2x

1

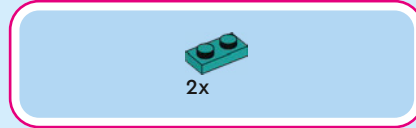
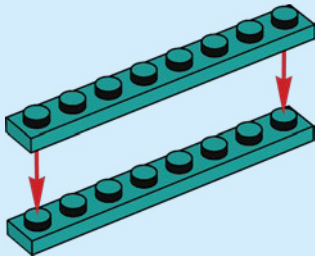

2x

2

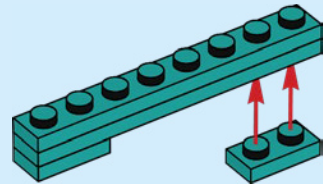

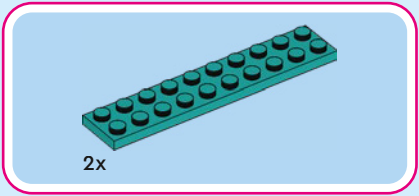

3

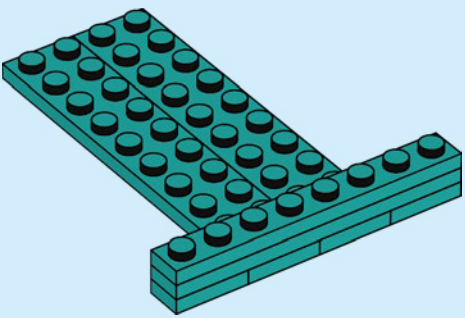

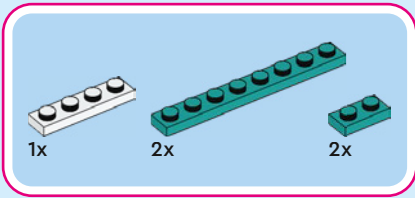

4

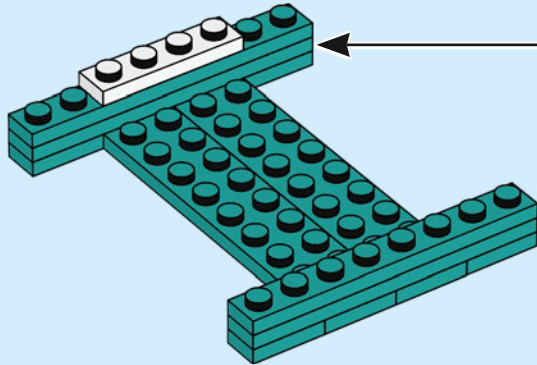
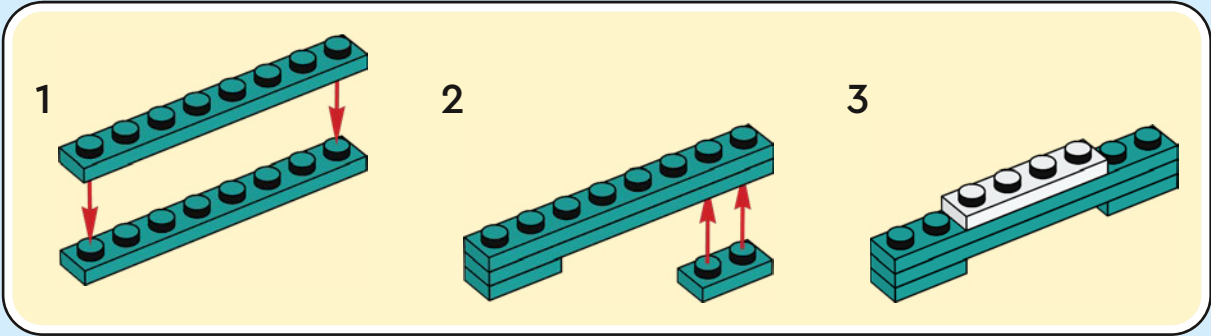

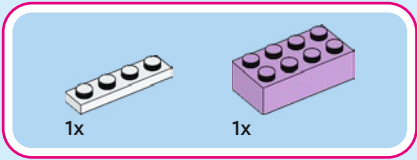

5

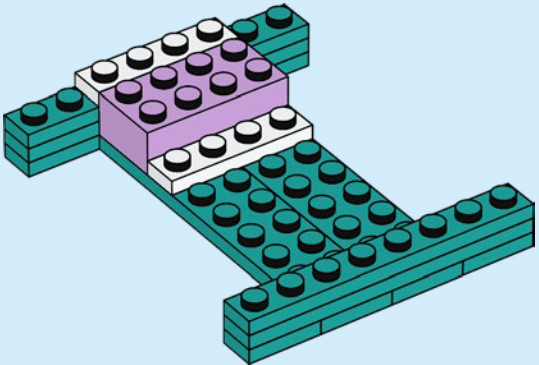



6

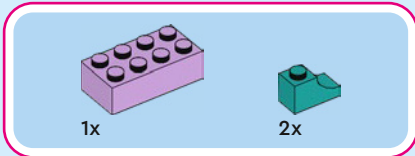
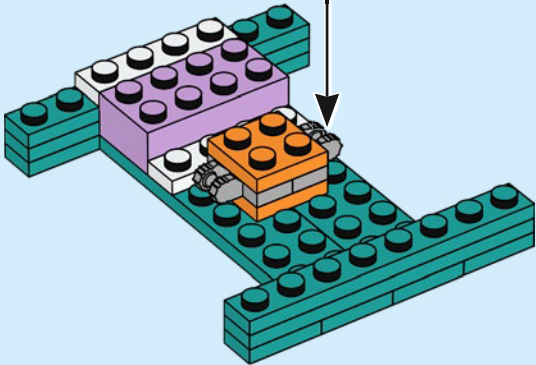
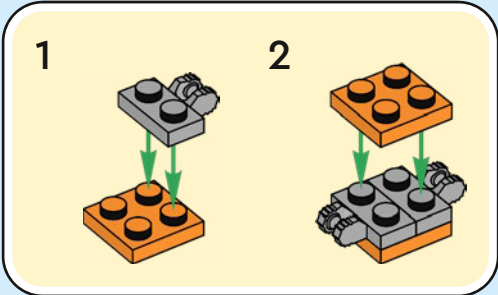

7

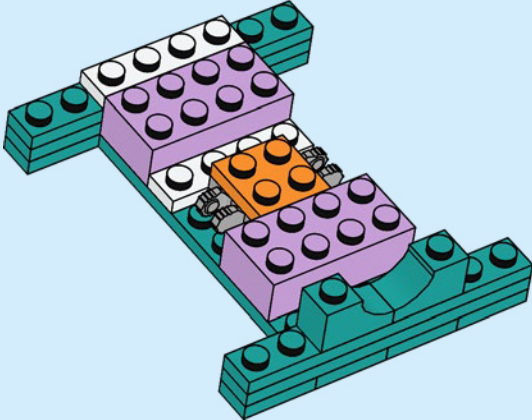

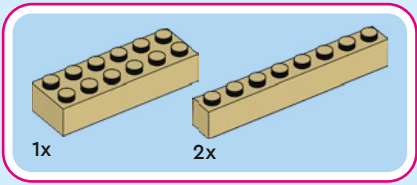

8

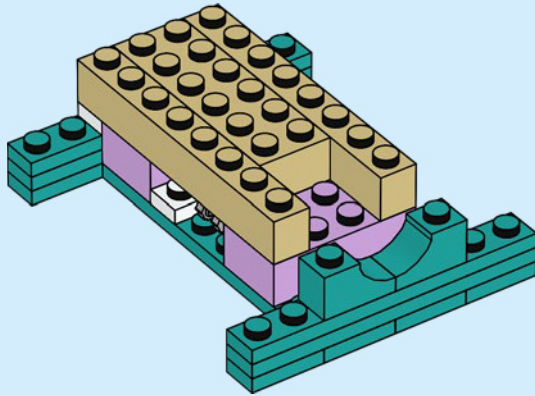

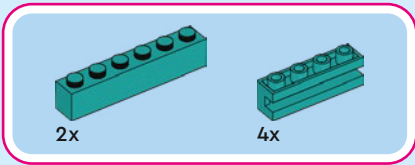

9

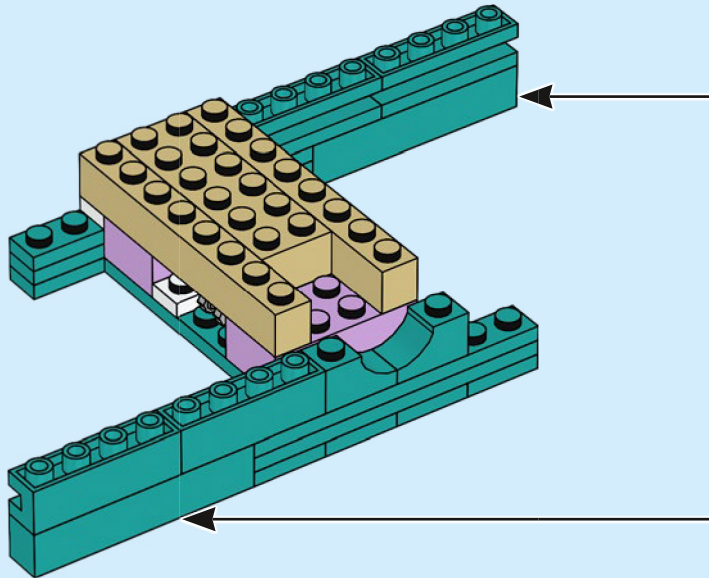
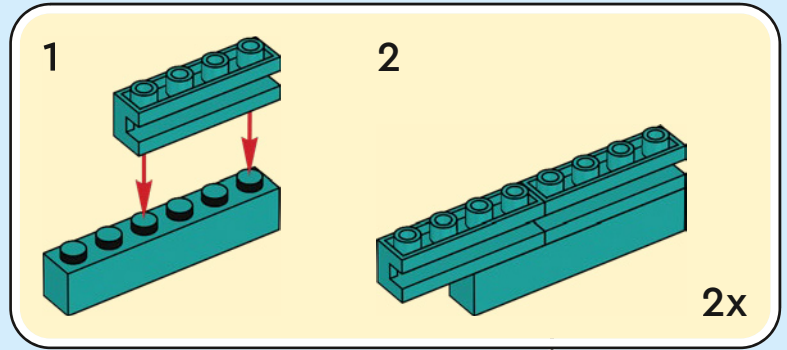

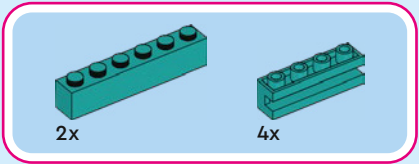

10

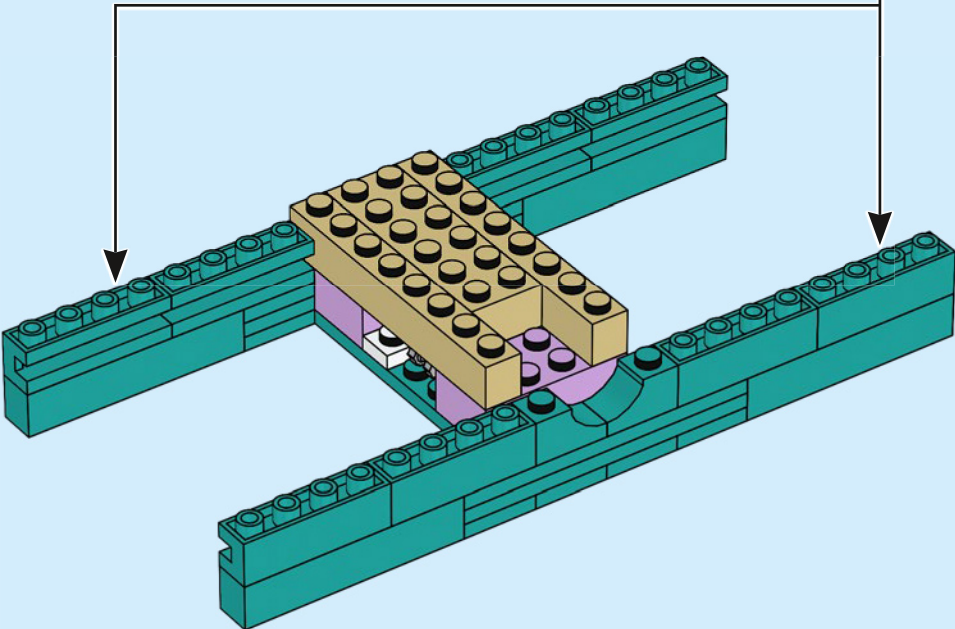
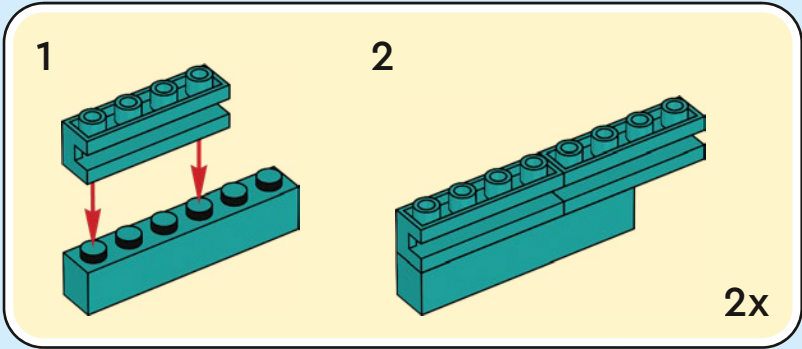



6x

11

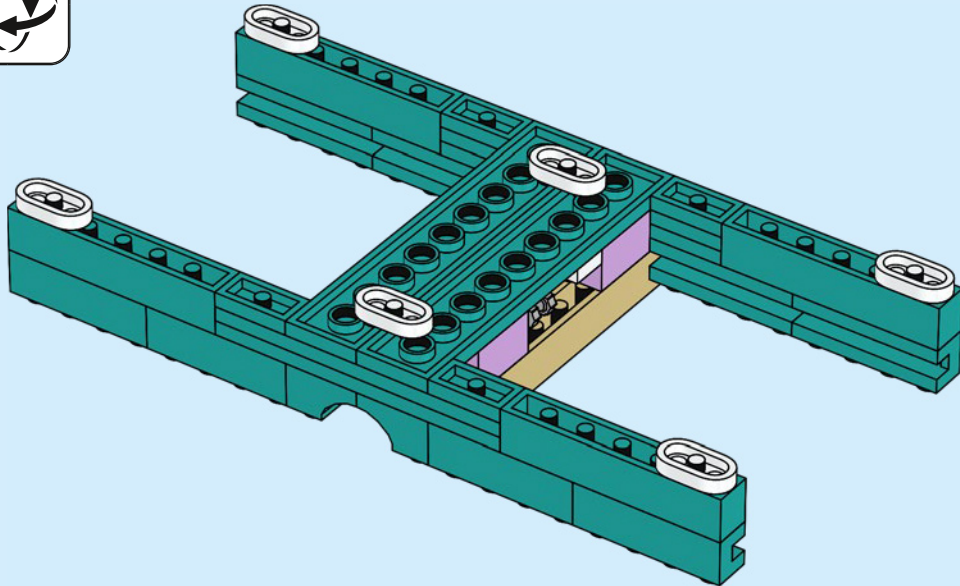

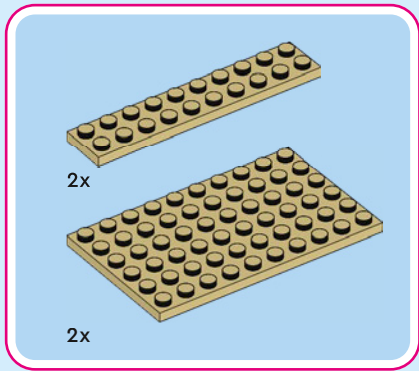

12

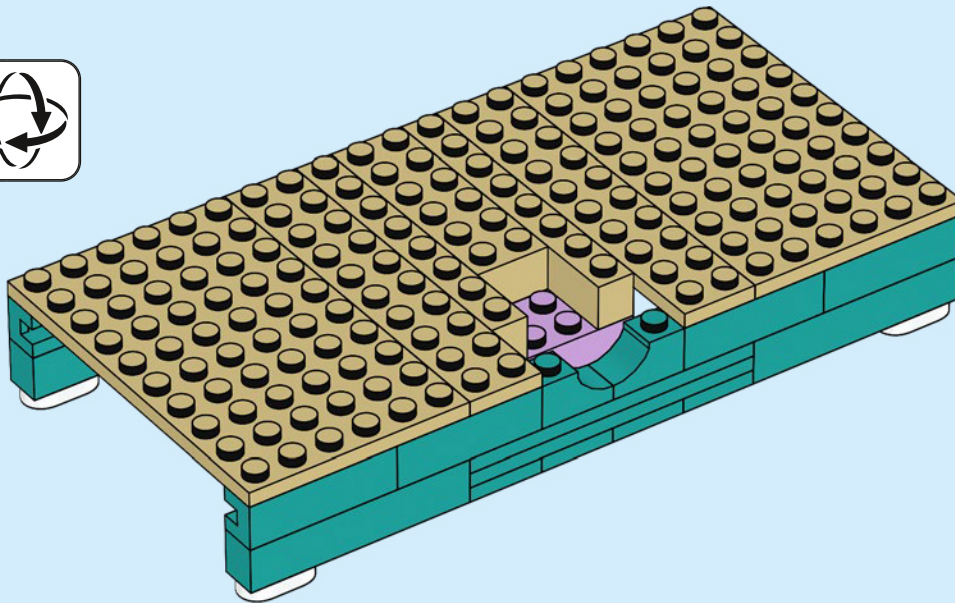
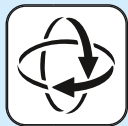



2x



3x

13

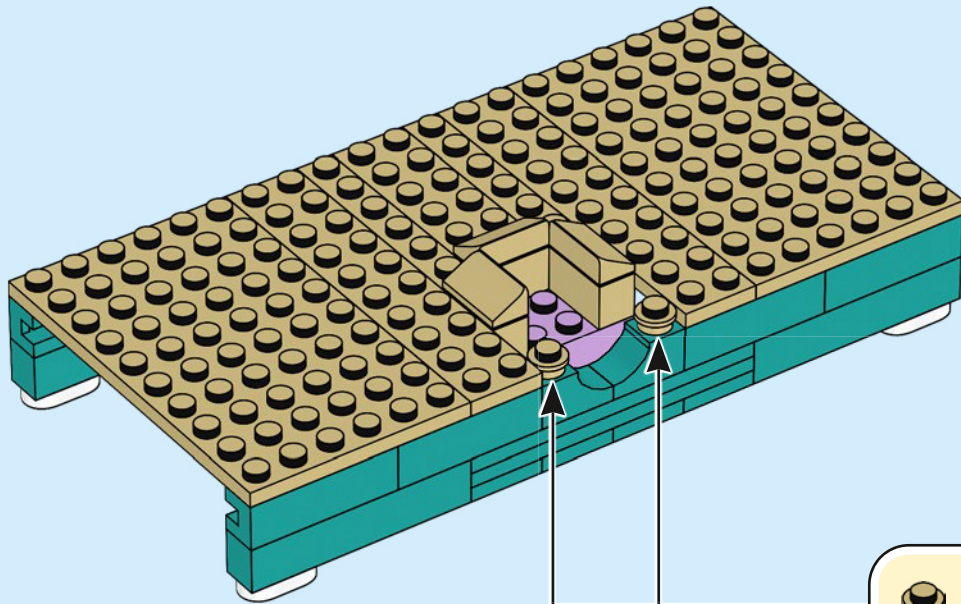

2x



1x

14

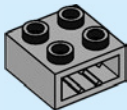

1x



1x

15

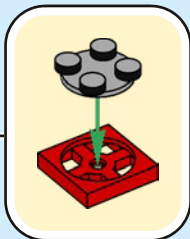

1x

16



1x



1x

17

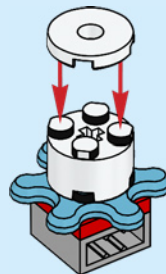

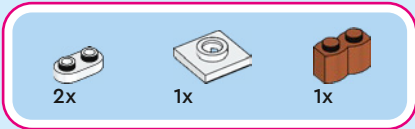

18

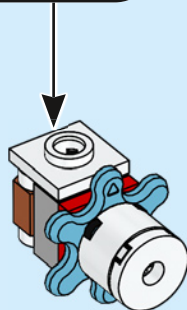
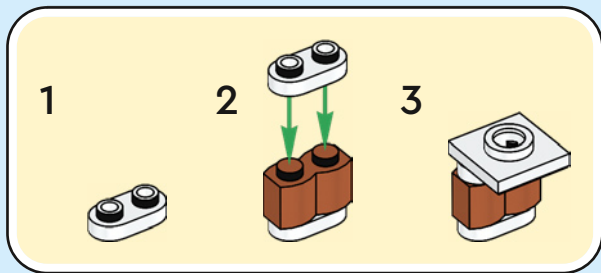

19

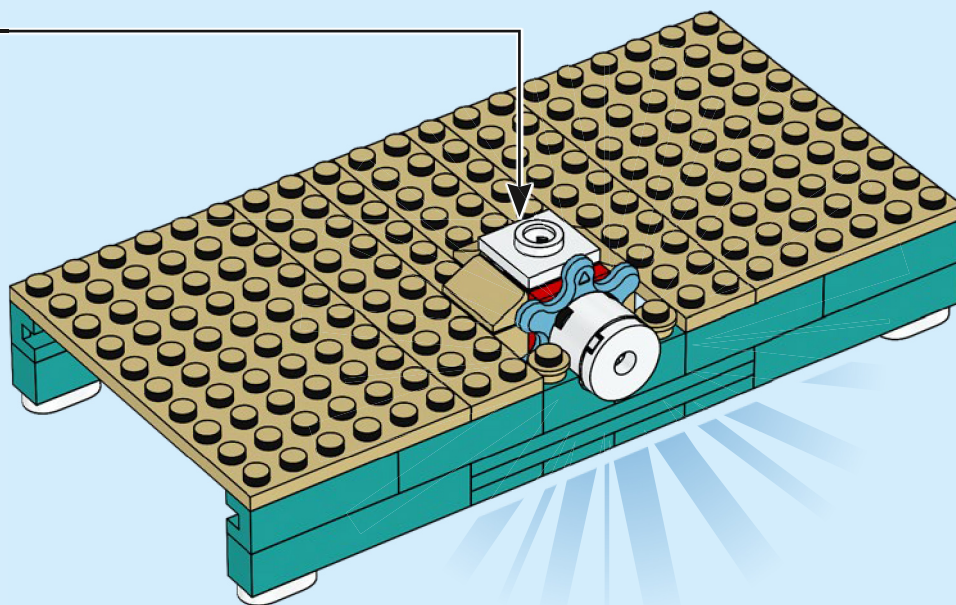

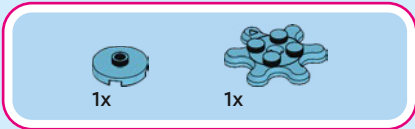

20

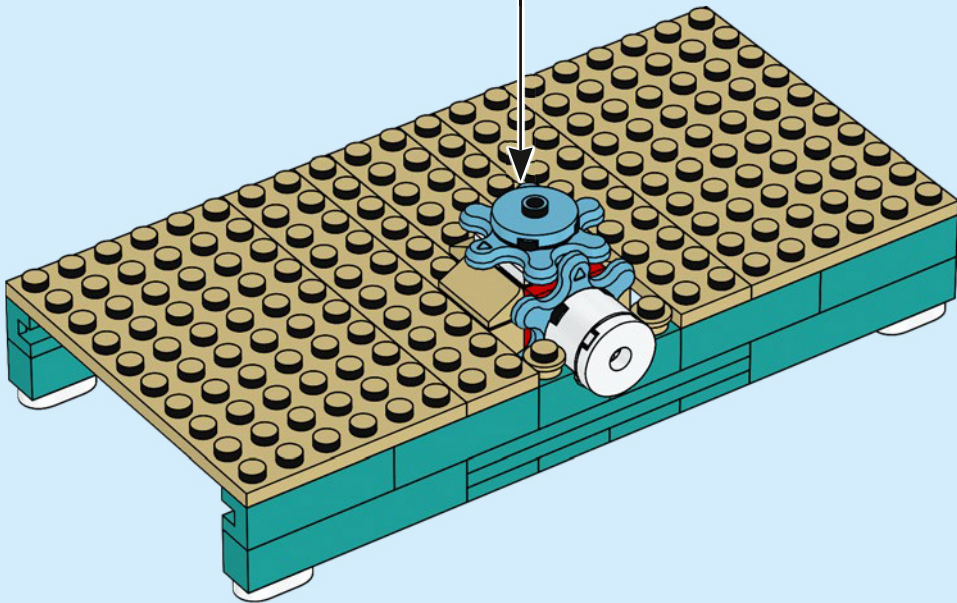
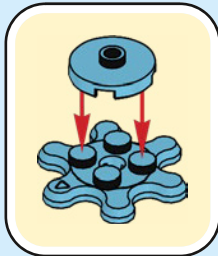

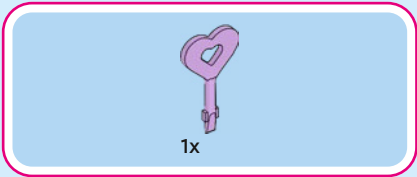

21

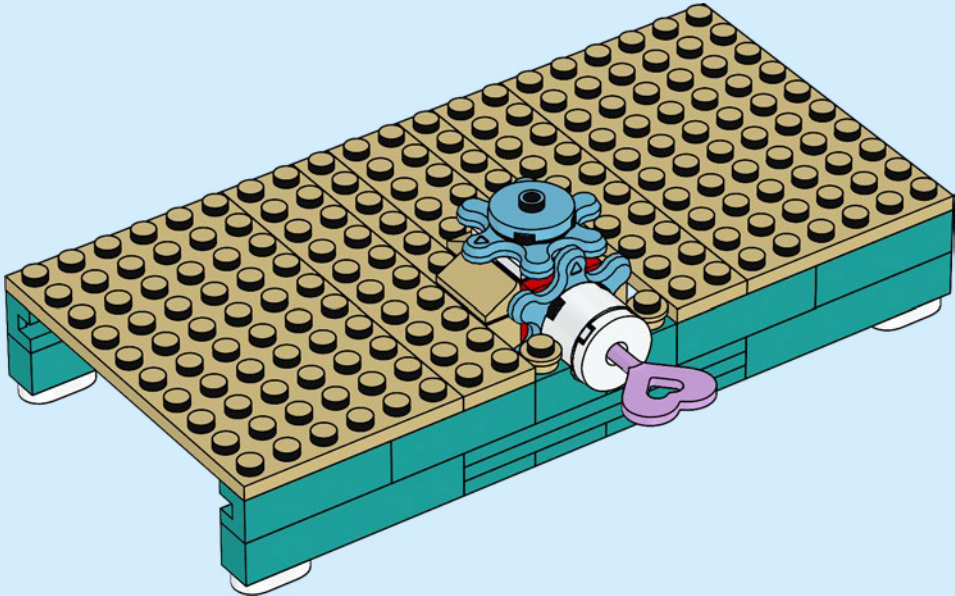

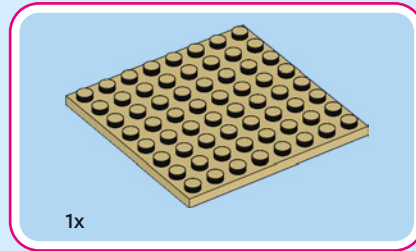
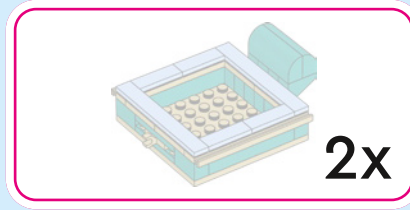

22

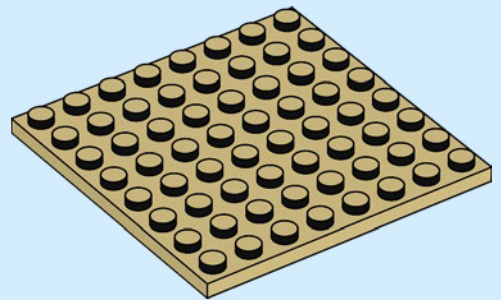

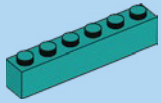

2x

23

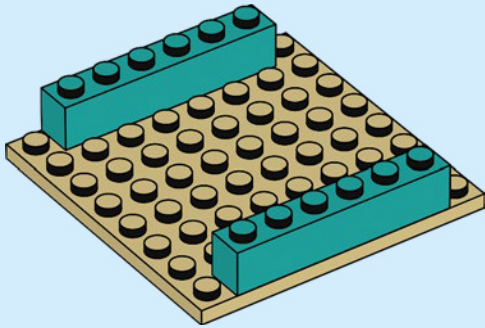

4x

24

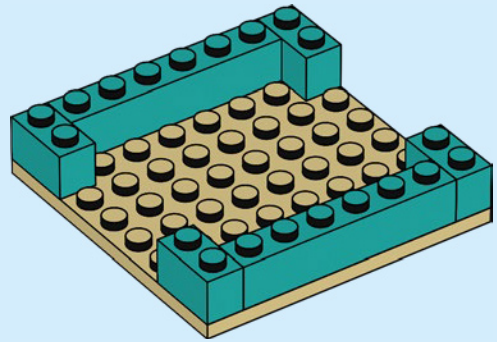

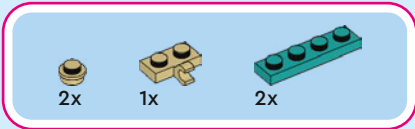

25

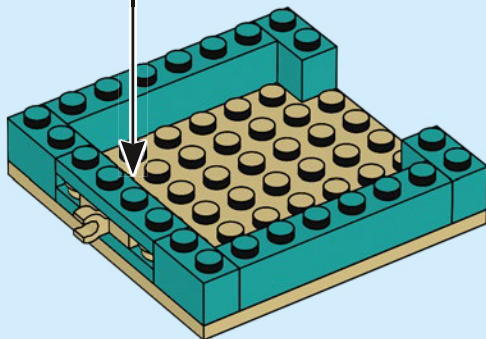
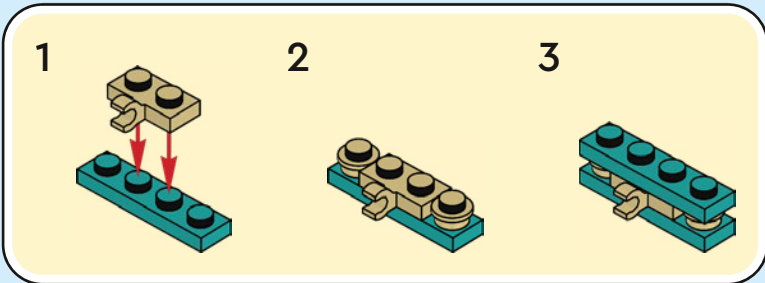

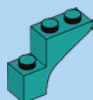

4x

26

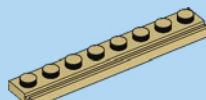
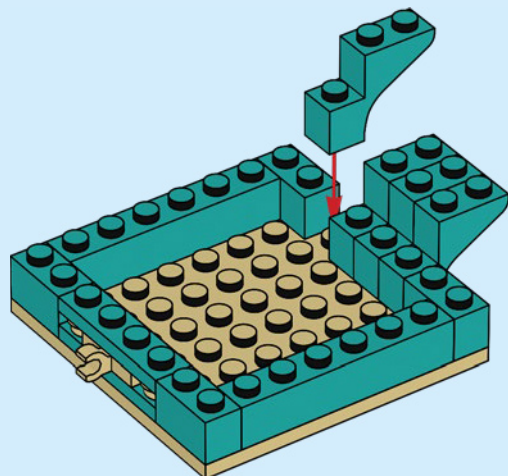

2x

27

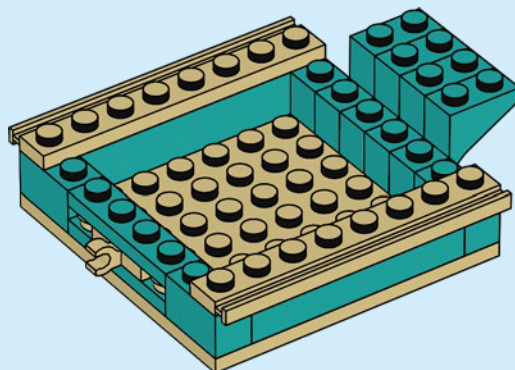

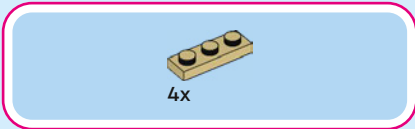

28

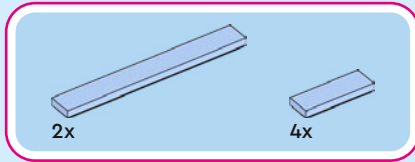
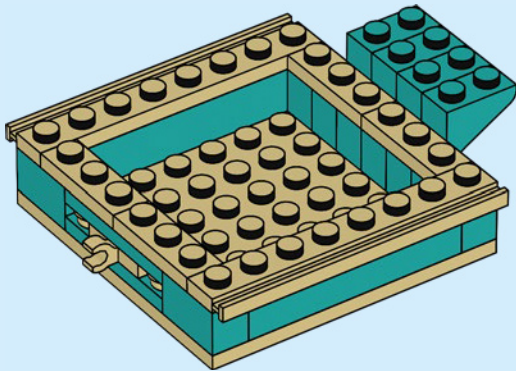

29

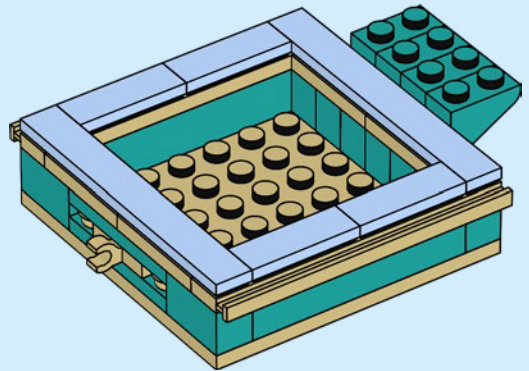



4x

30

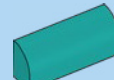
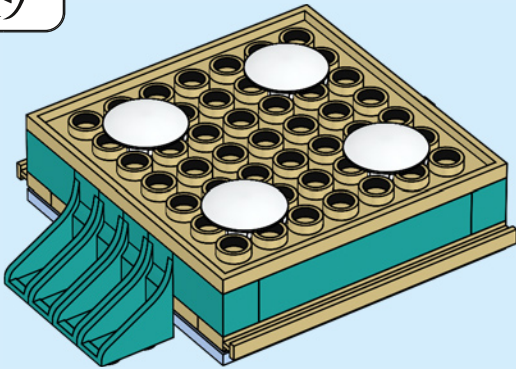

2x

31

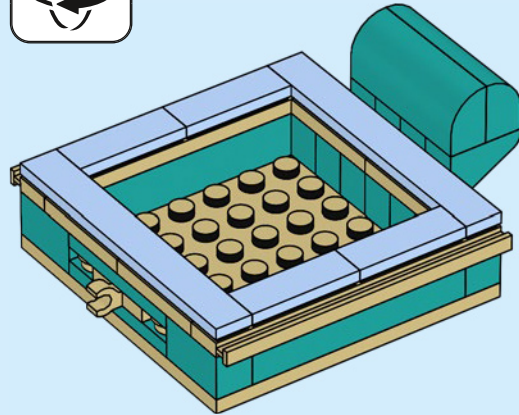

2x



32

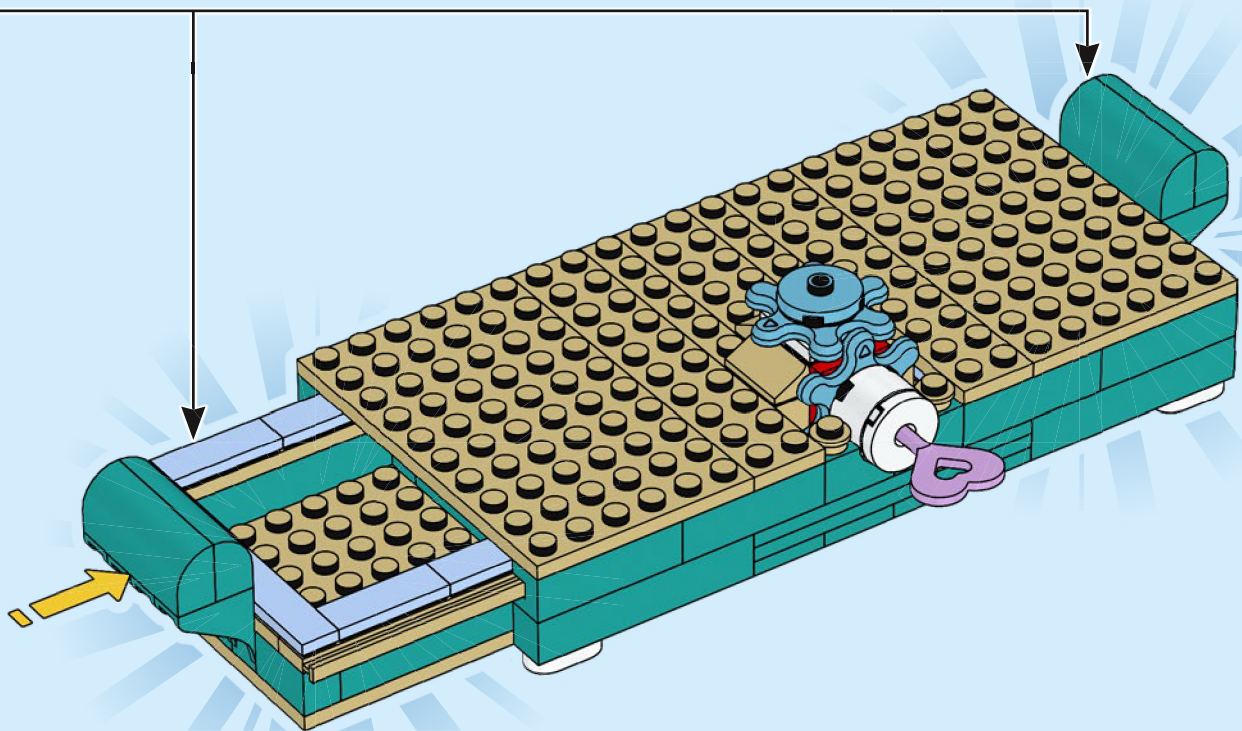

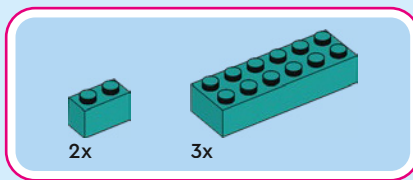

33

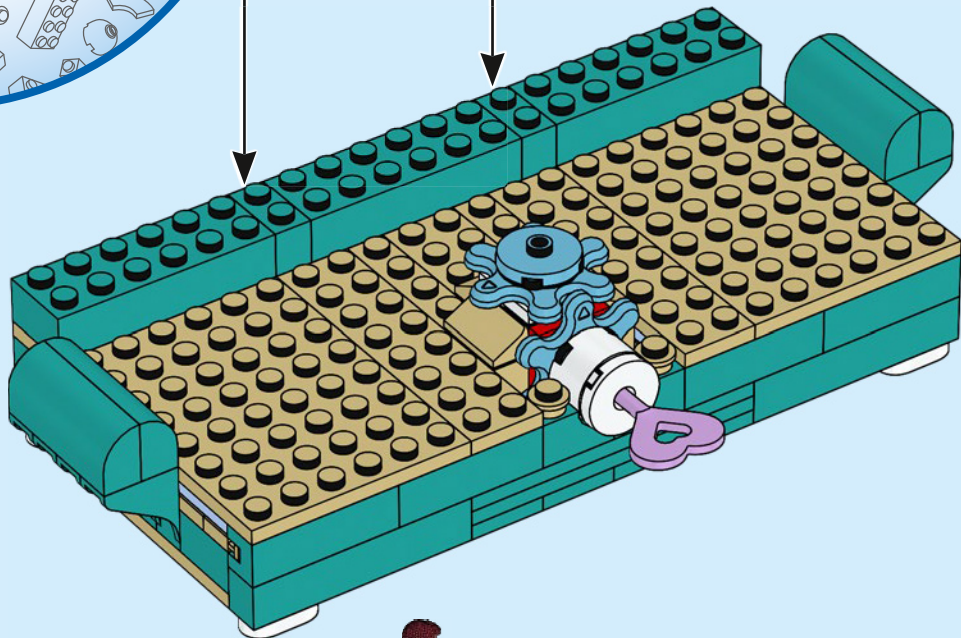
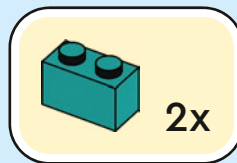

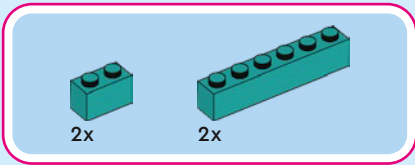

34

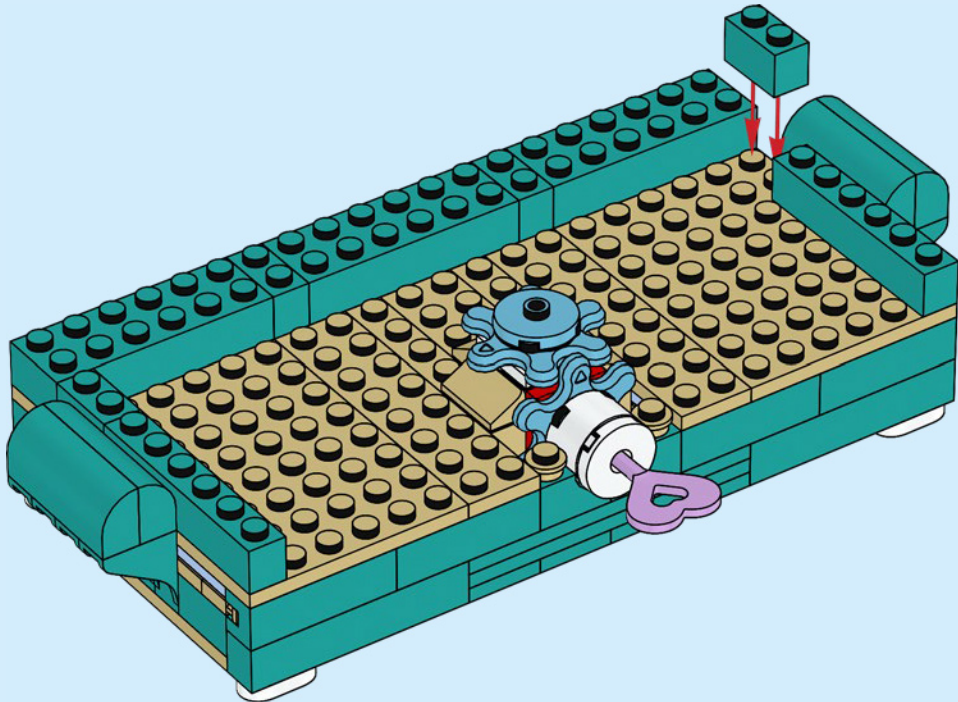

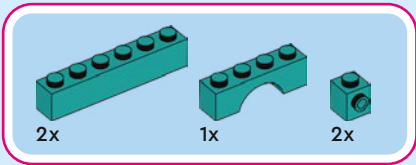

35

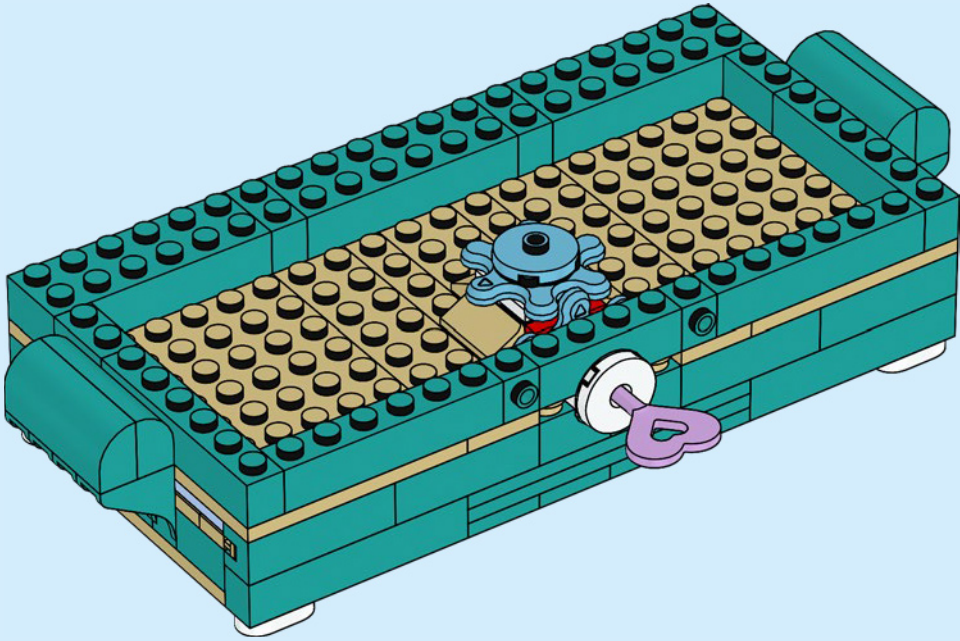

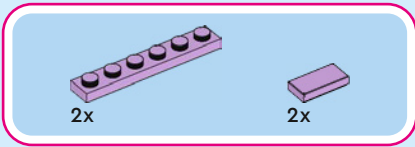

36

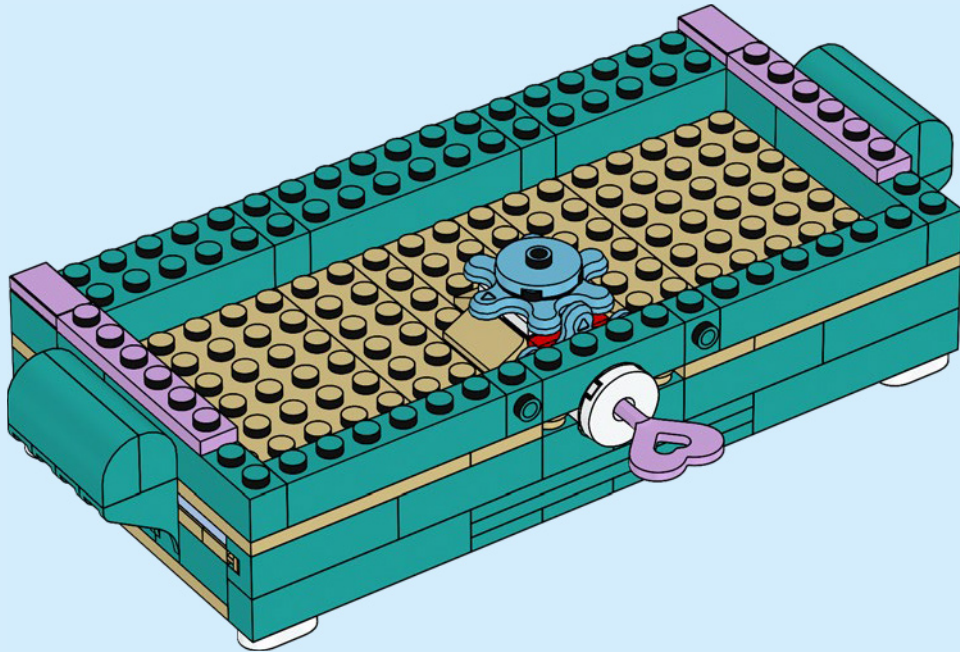

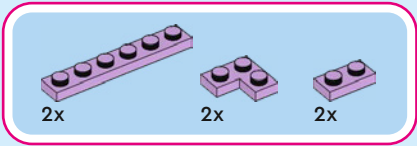

37

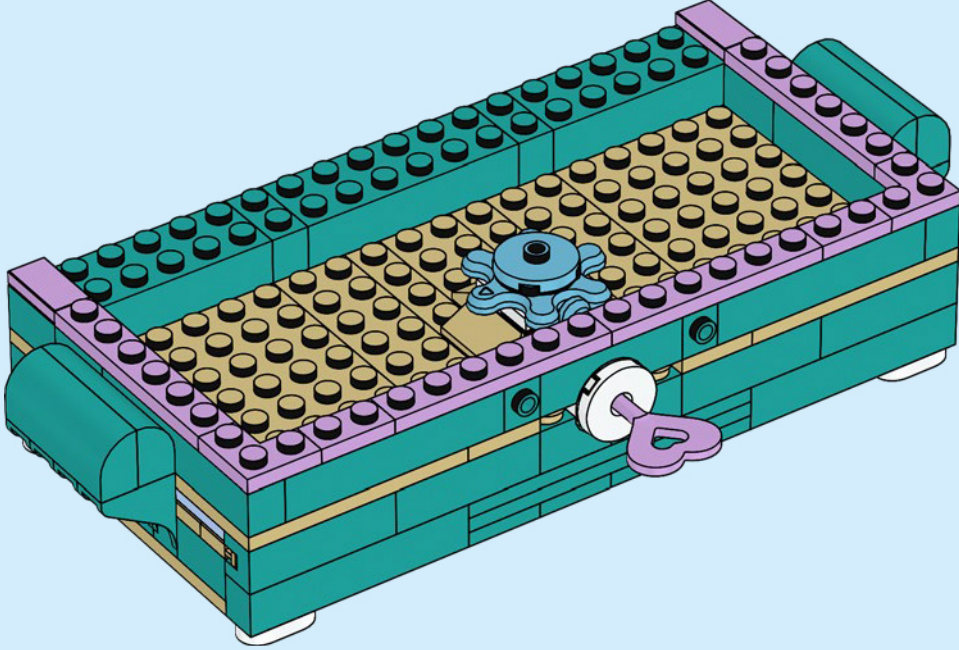



2x



2x

38

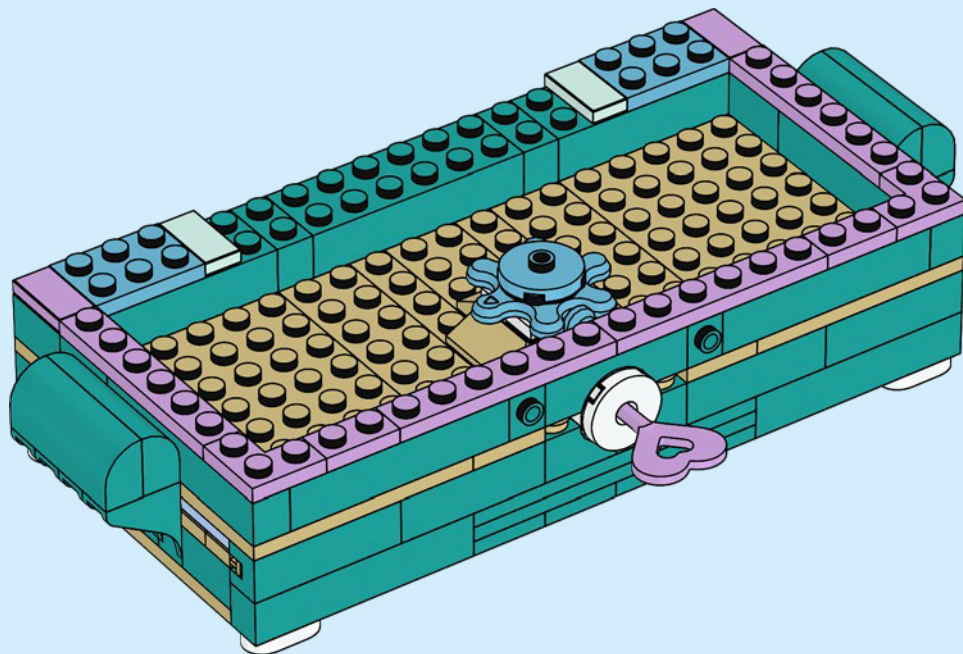



3x

39

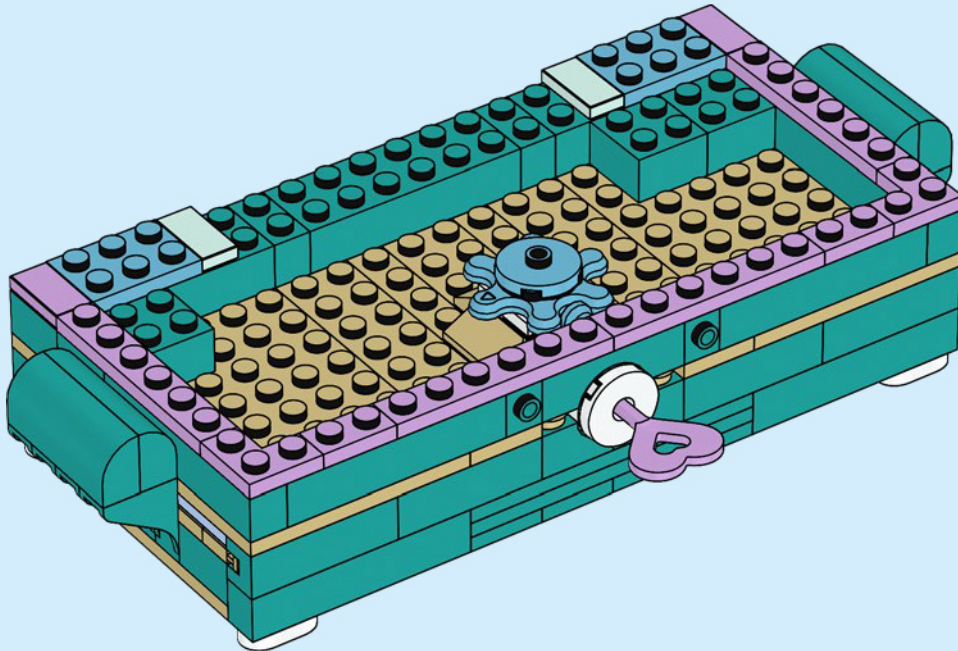



1x

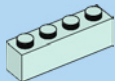

2x

40

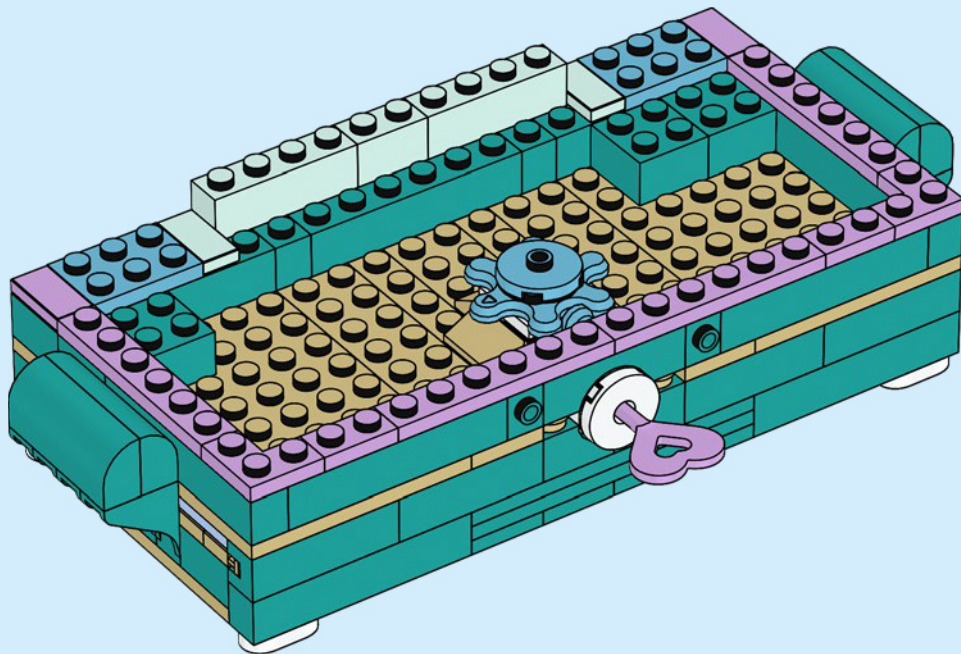

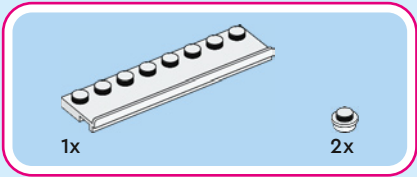

41

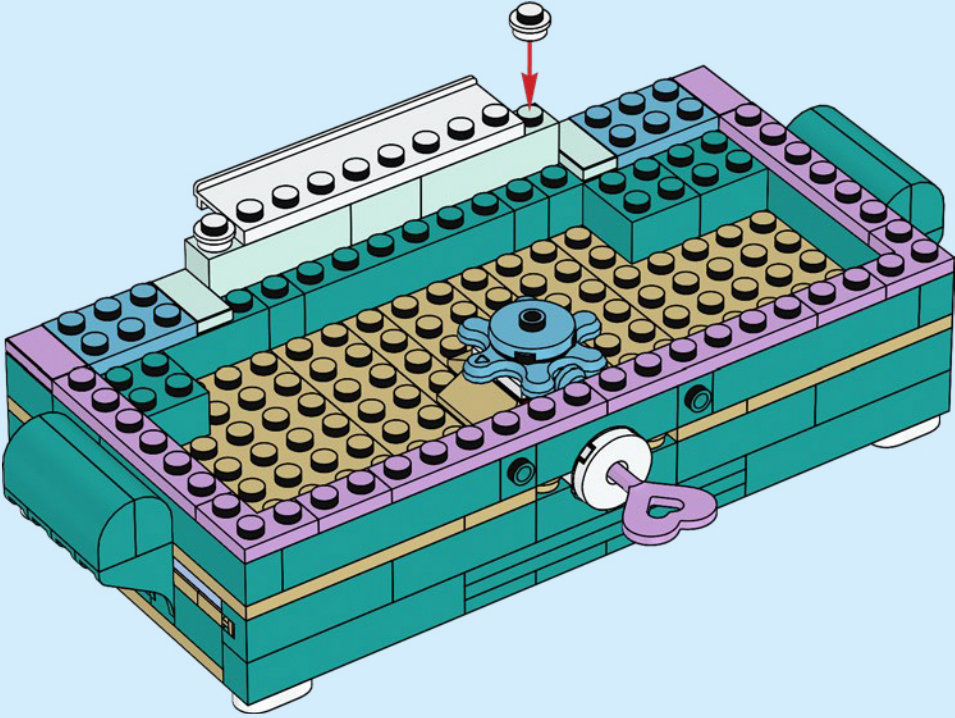

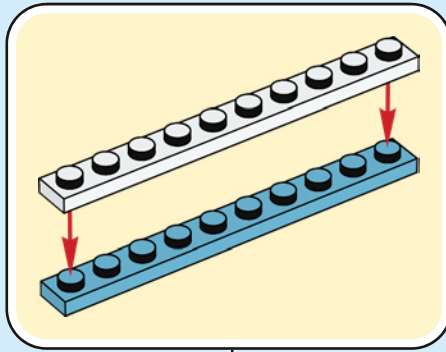
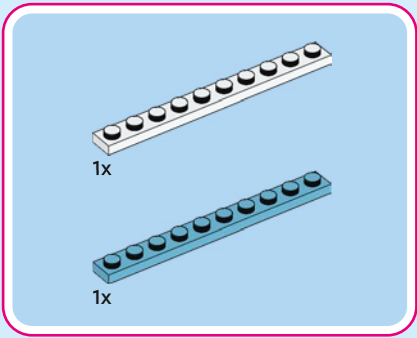

42

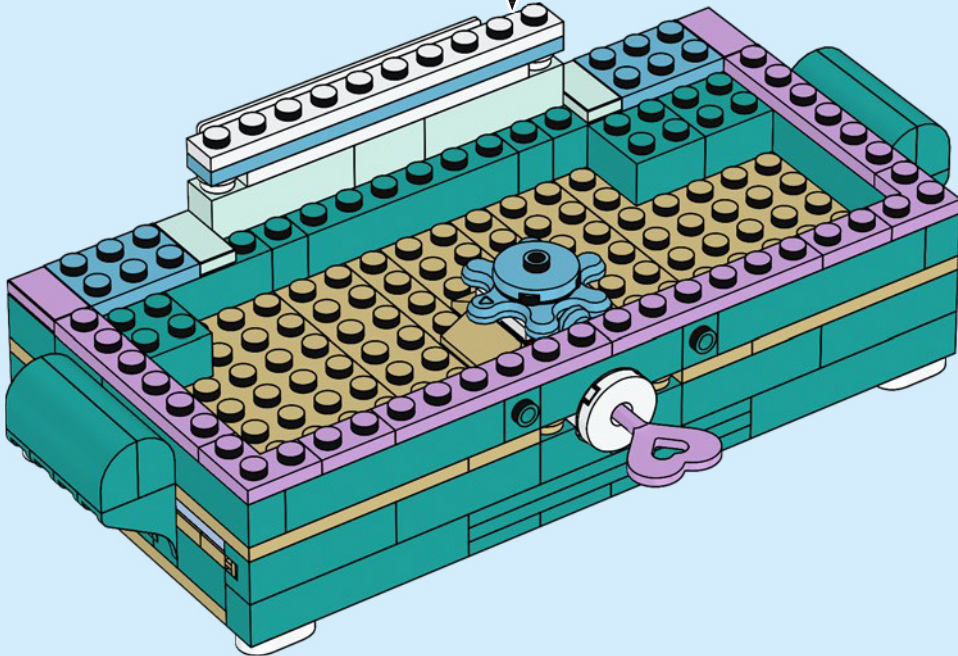



2x



1x

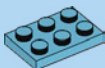

1x

43

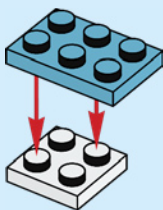

1x

44

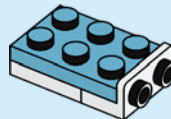

1x

45

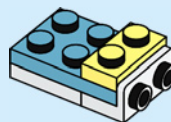

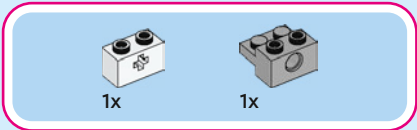

46

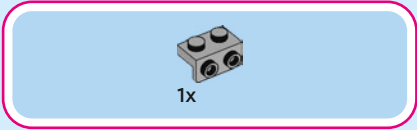
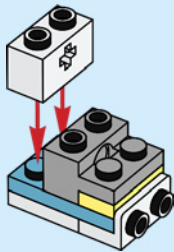

47

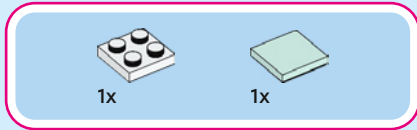
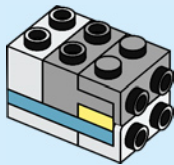

48

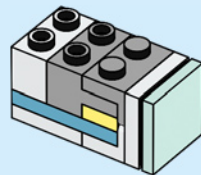
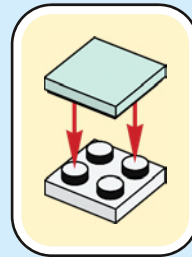

2x

49

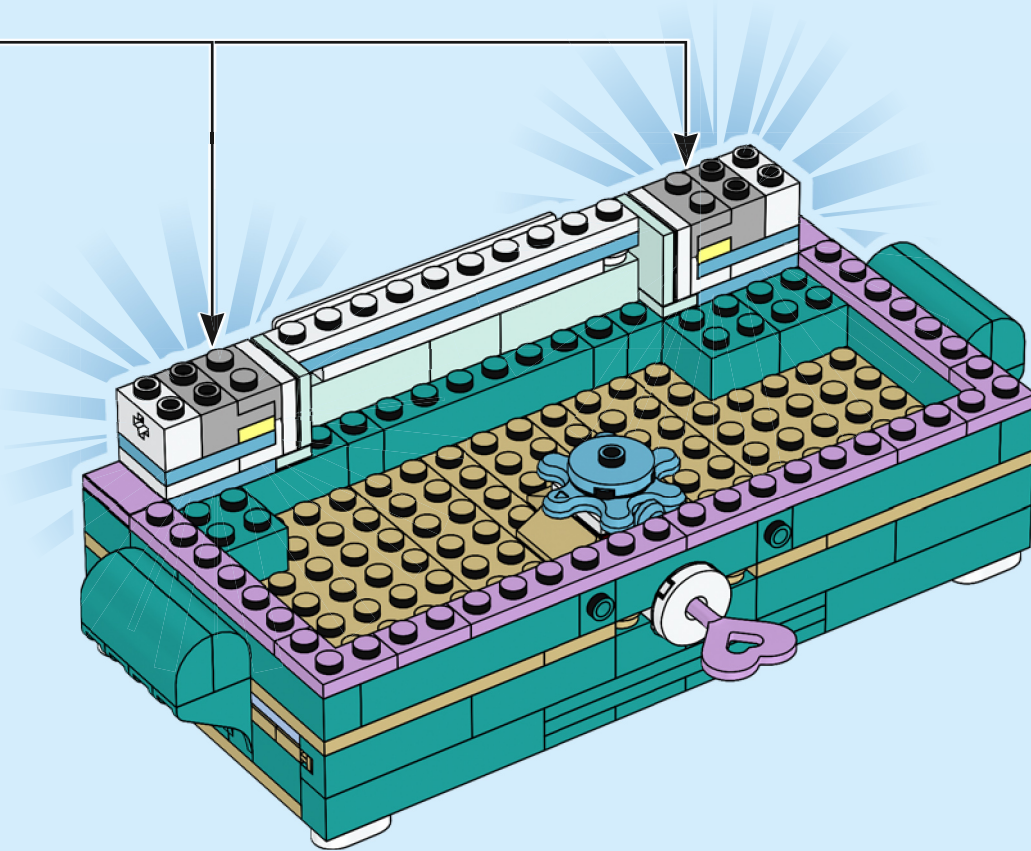

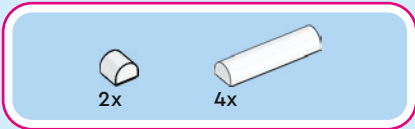

50

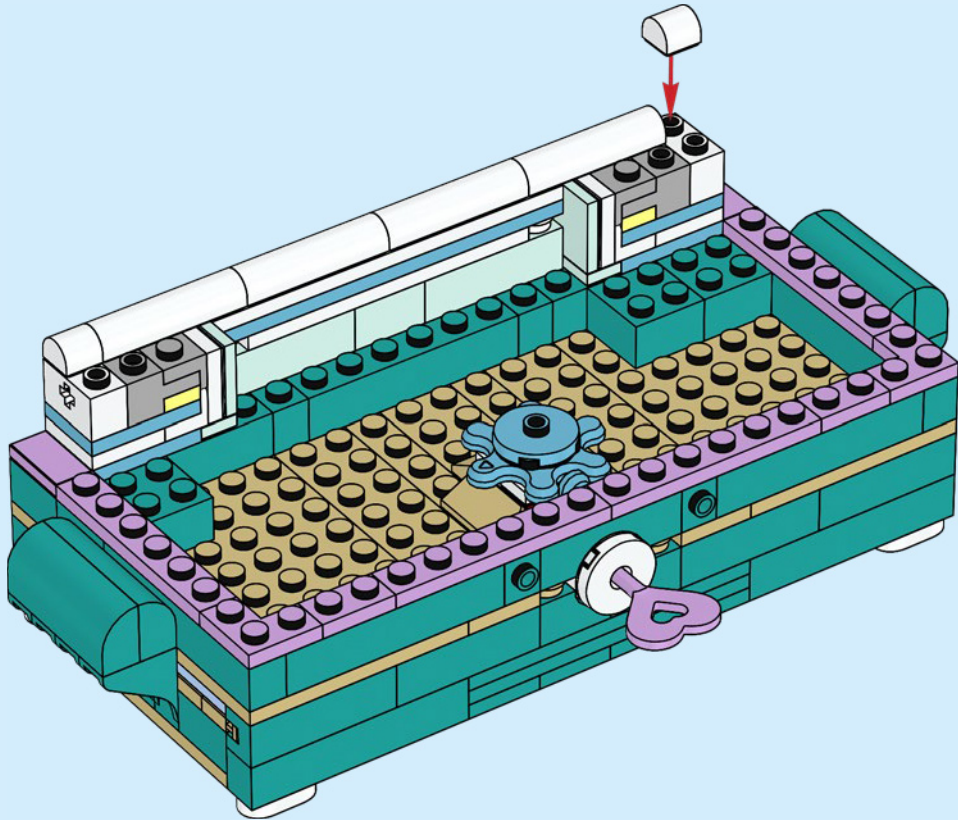



2x

51

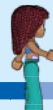
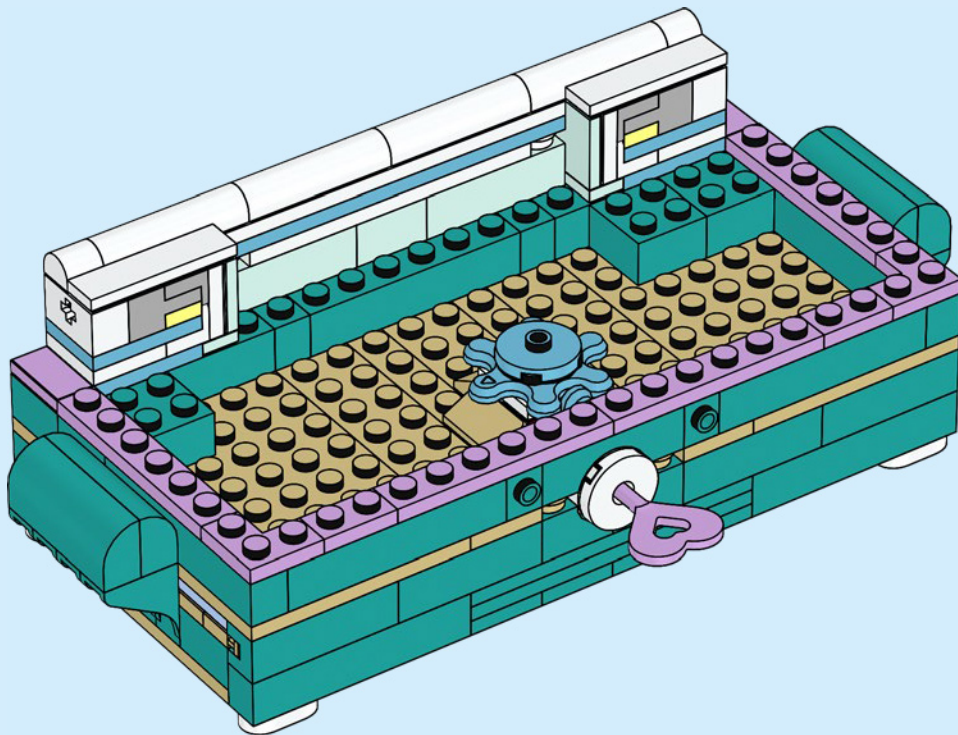



2x



1x

52

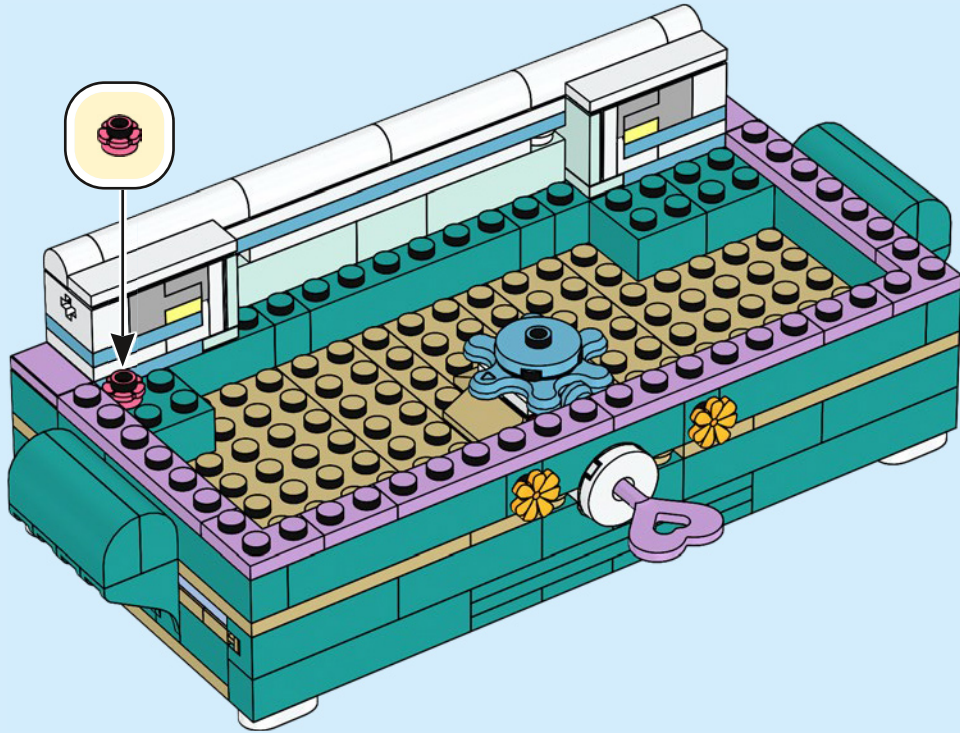



1x



1x

53

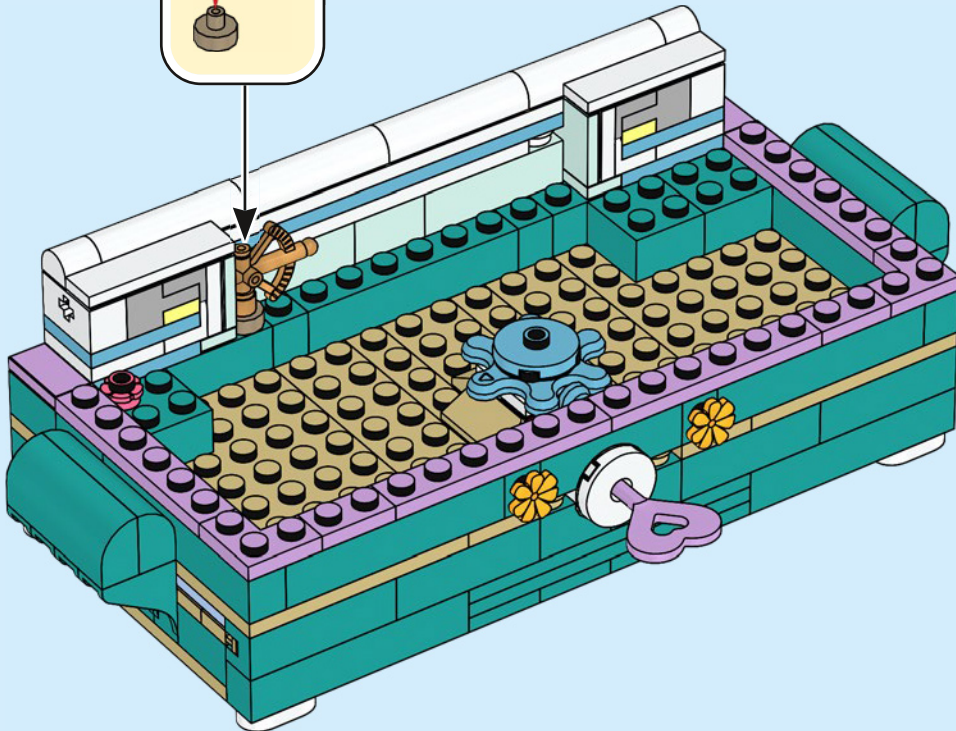
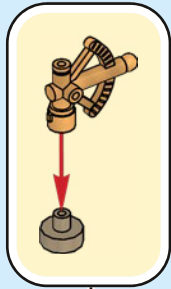

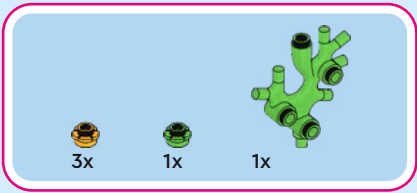

54

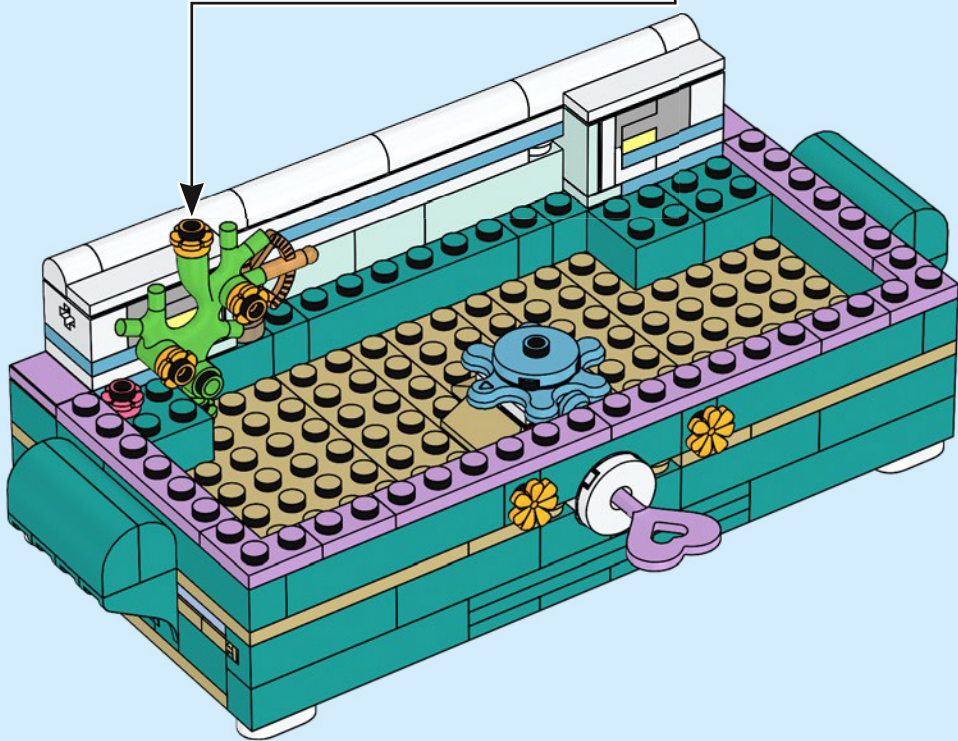
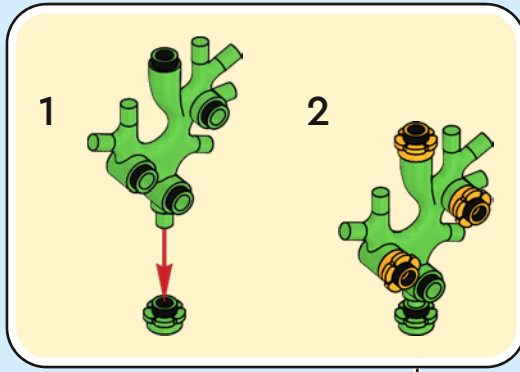

1x



1x



55

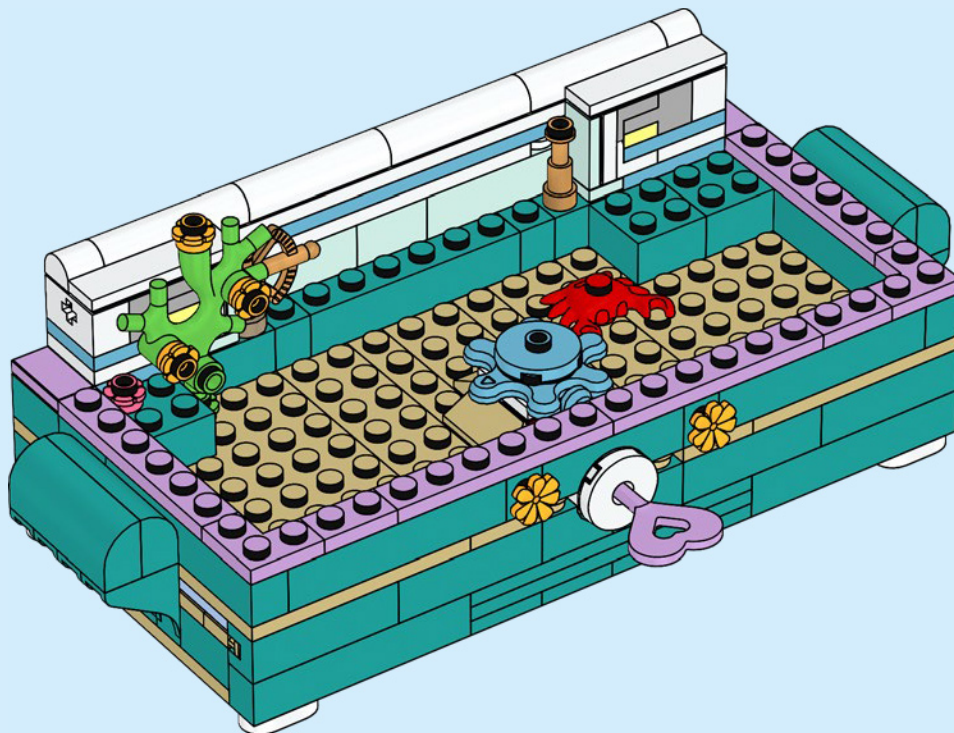



1x



1x

56

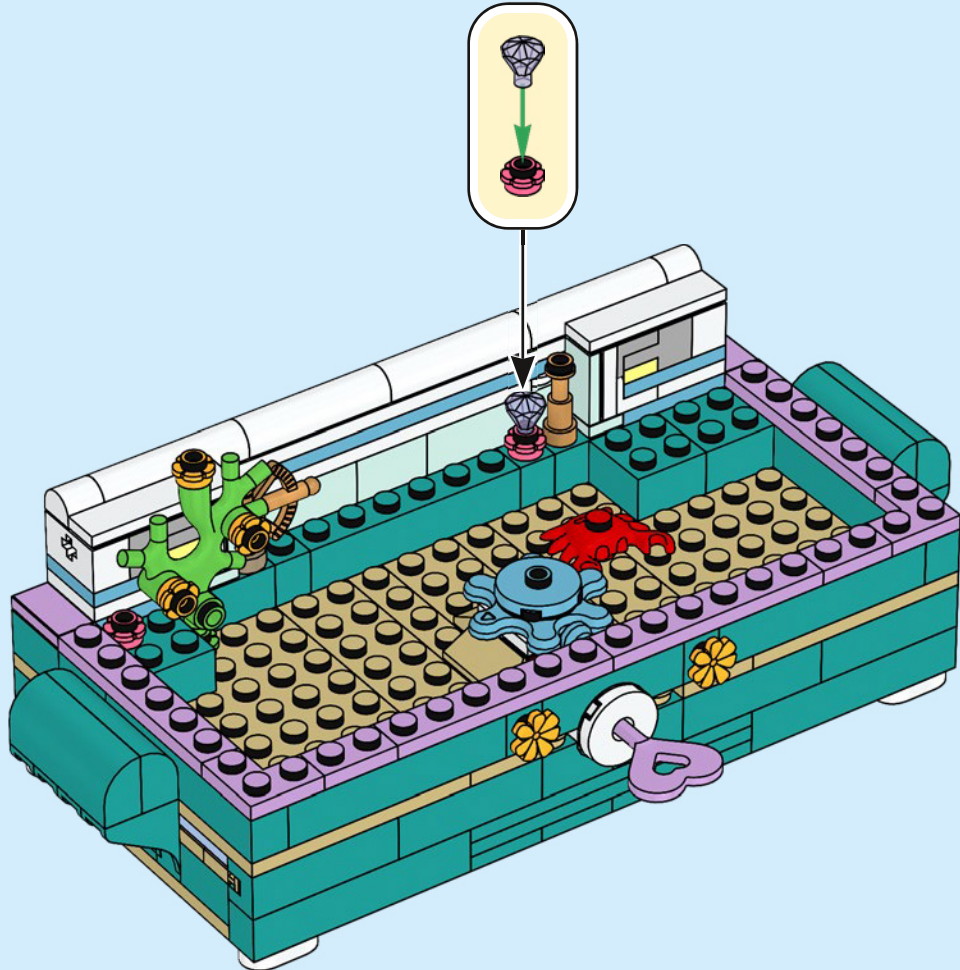

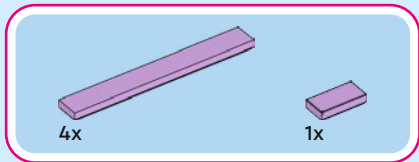

57

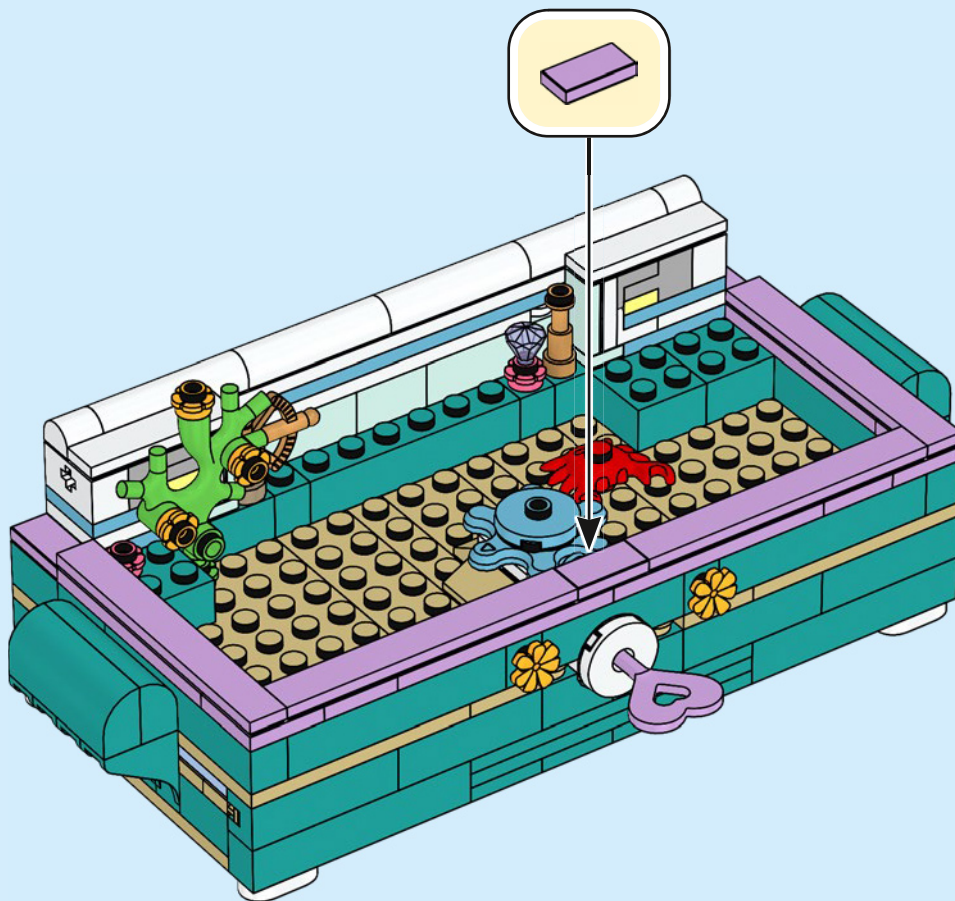

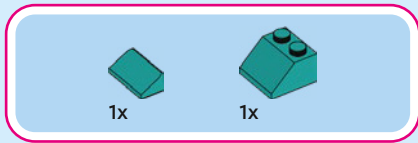

58

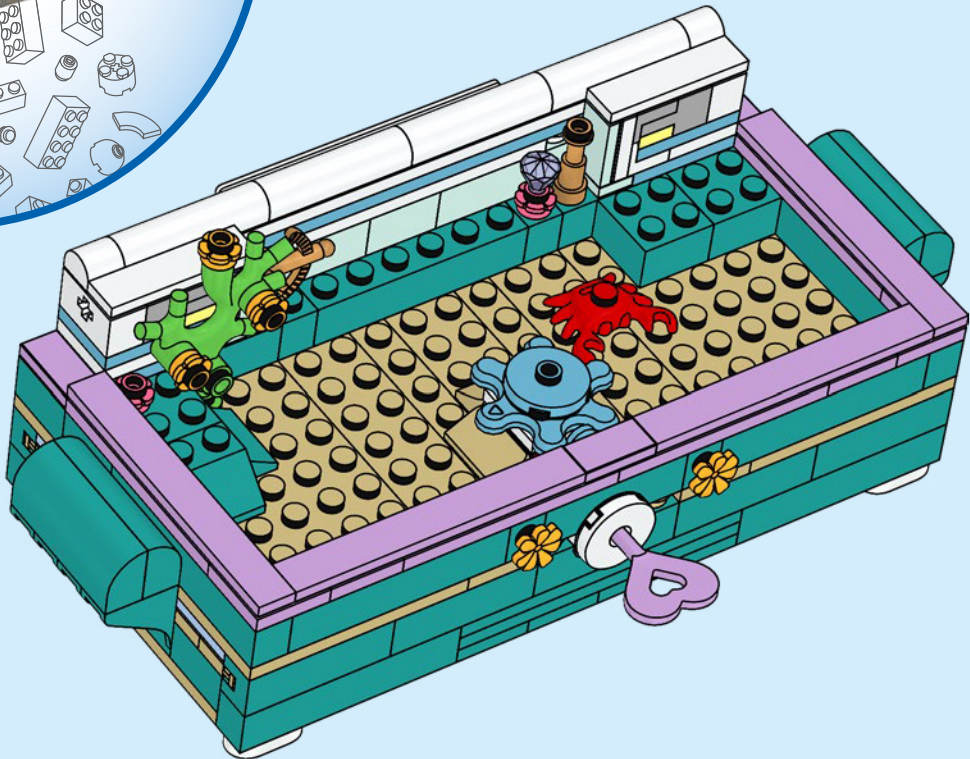

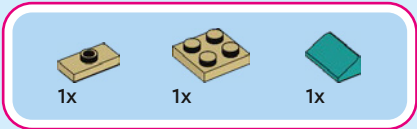

59

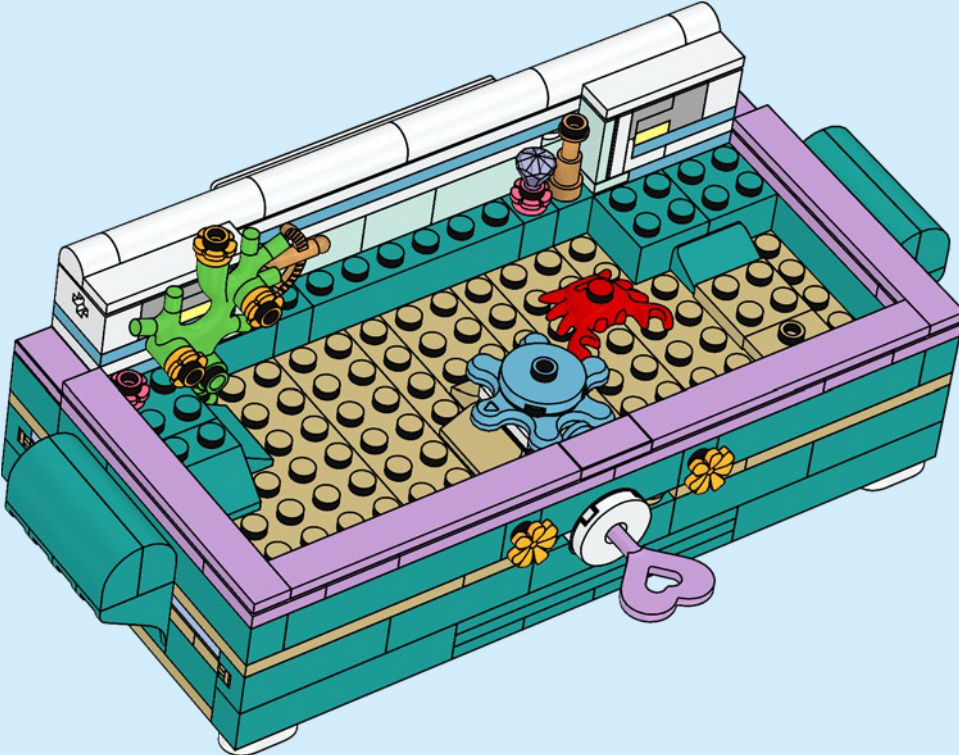



5x

60

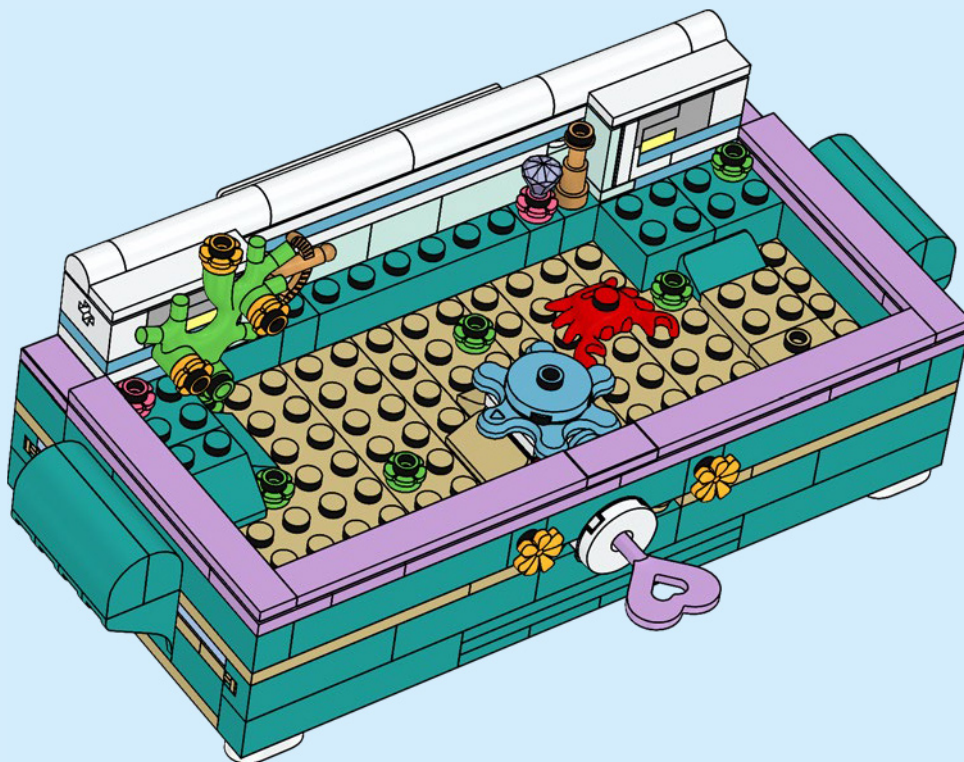

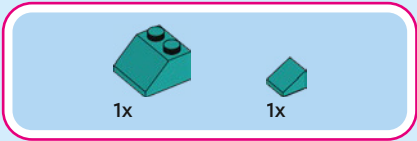

61

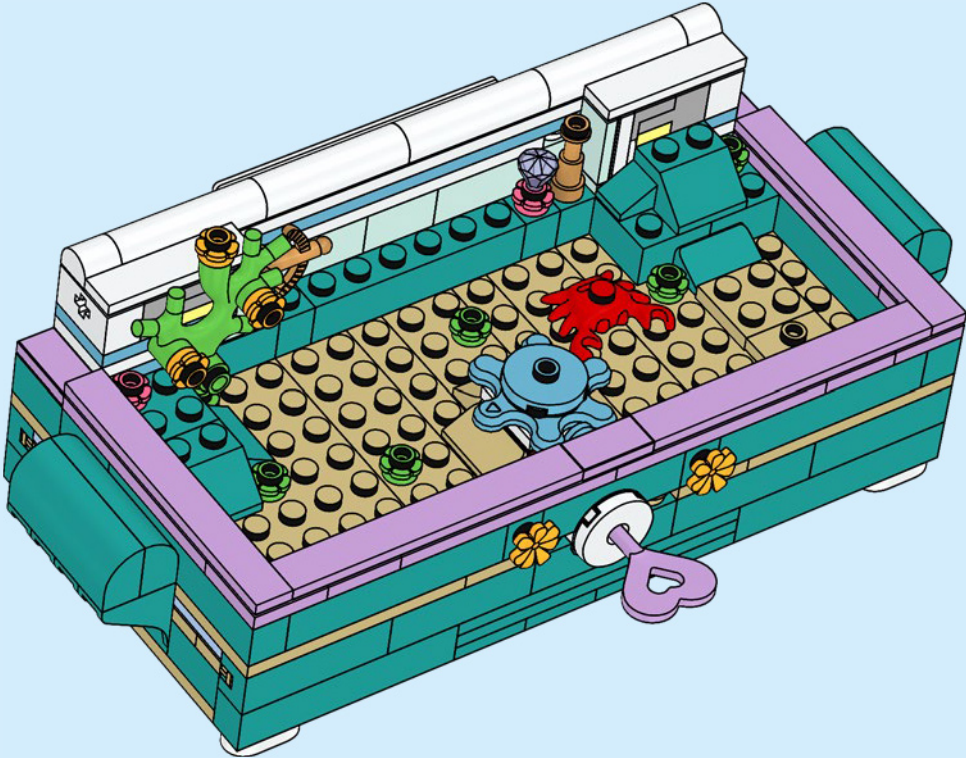

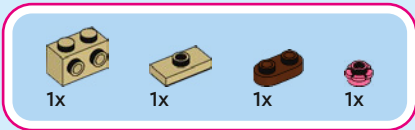

62

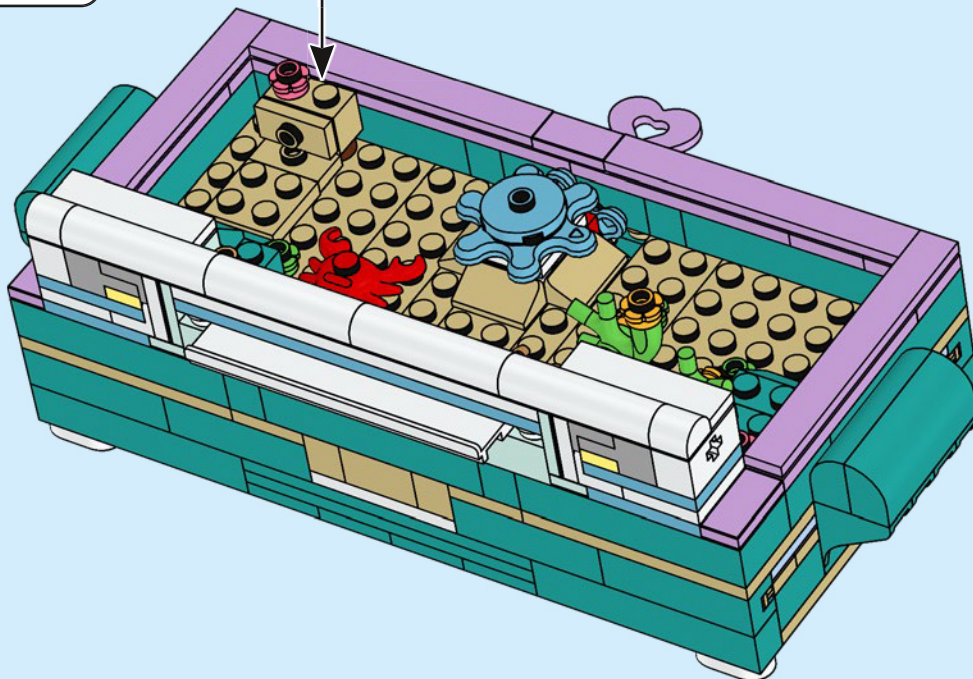
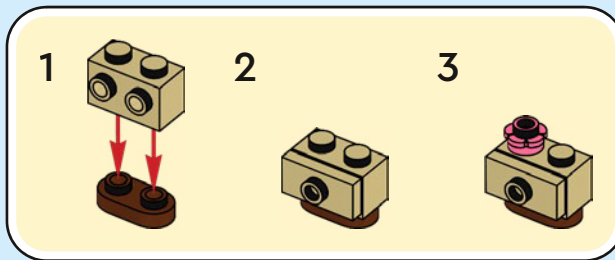



2x



2x

63

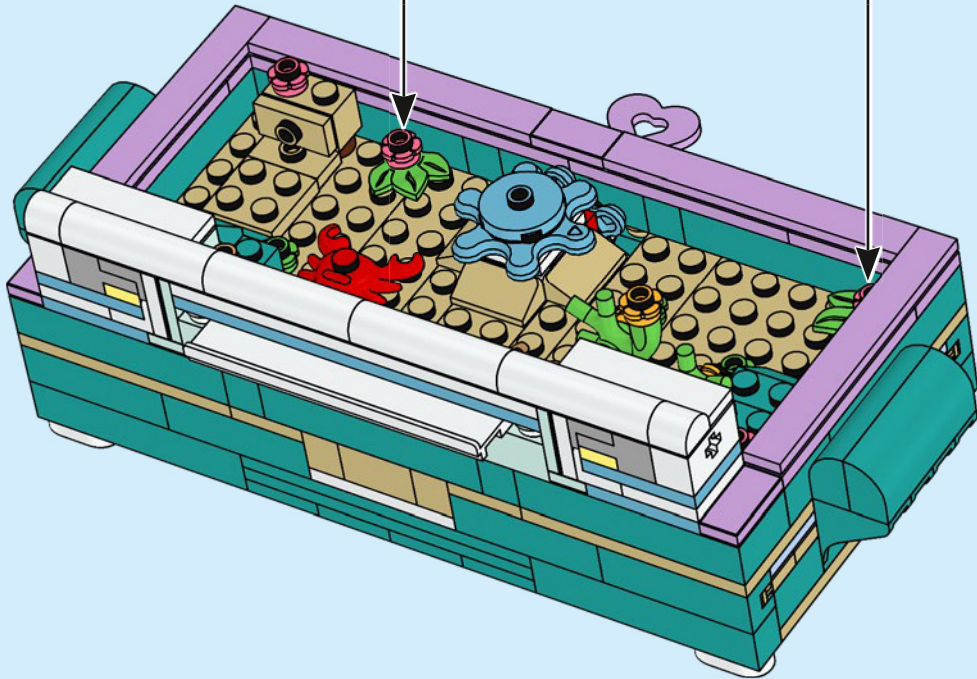
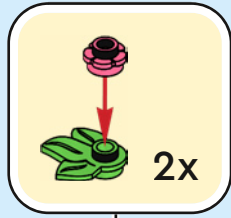

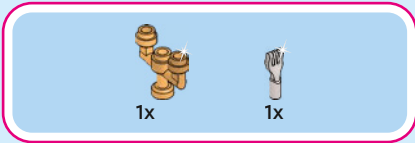

64

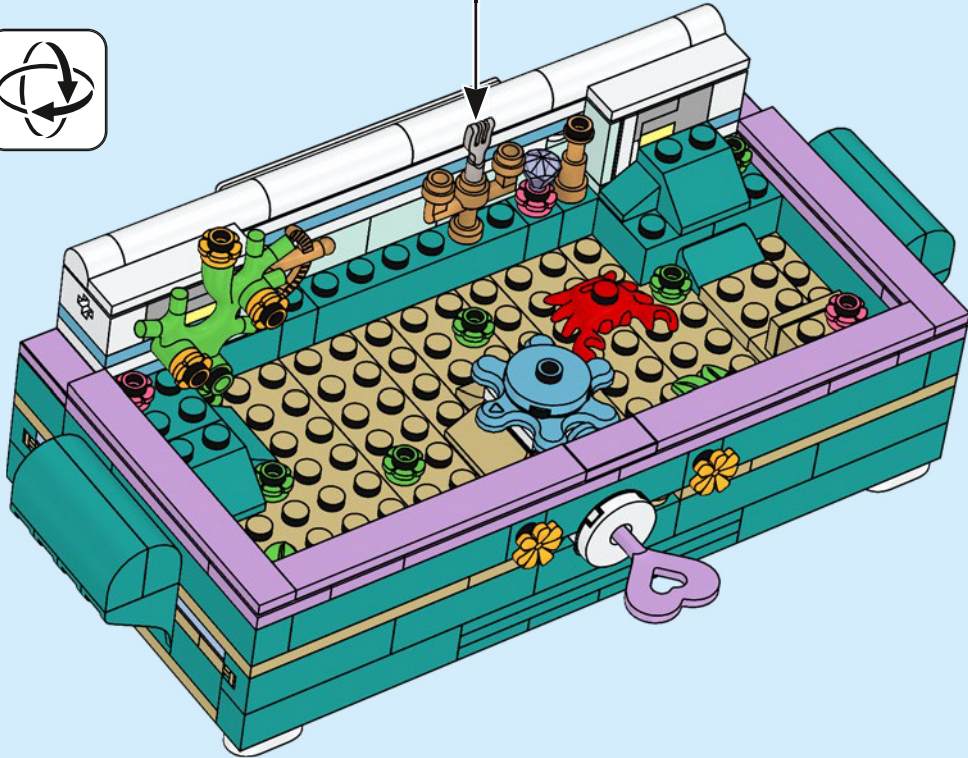
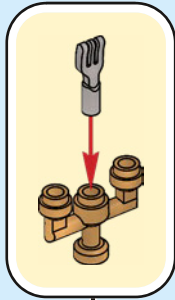



1x



1x

65

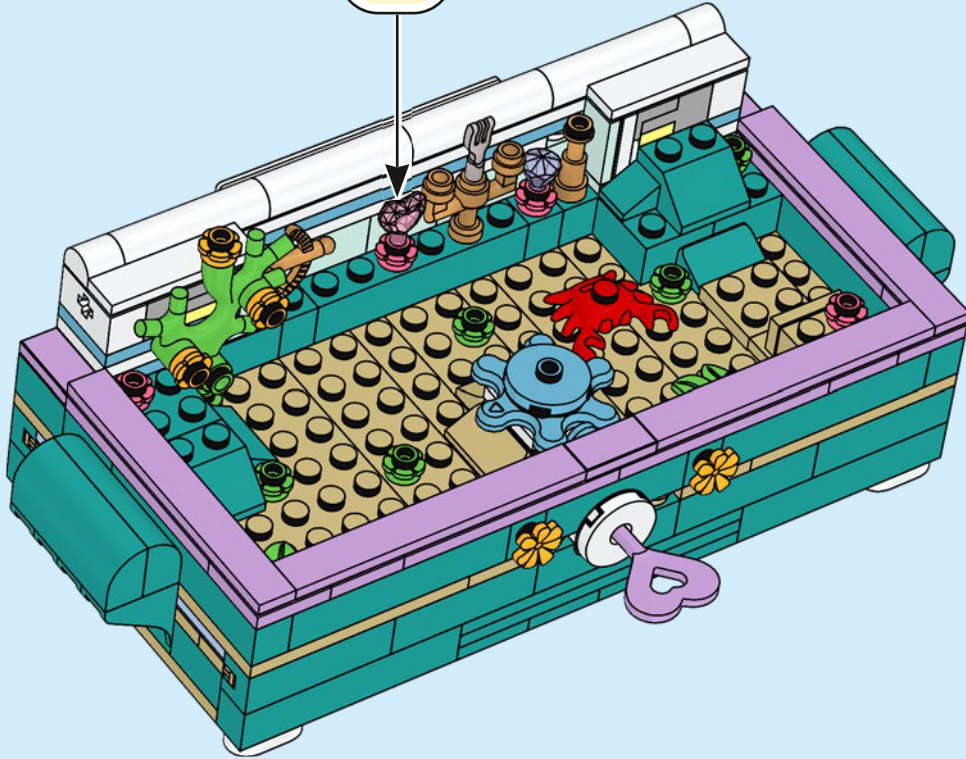
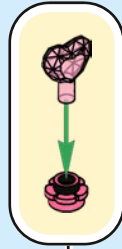



1x



1x

66

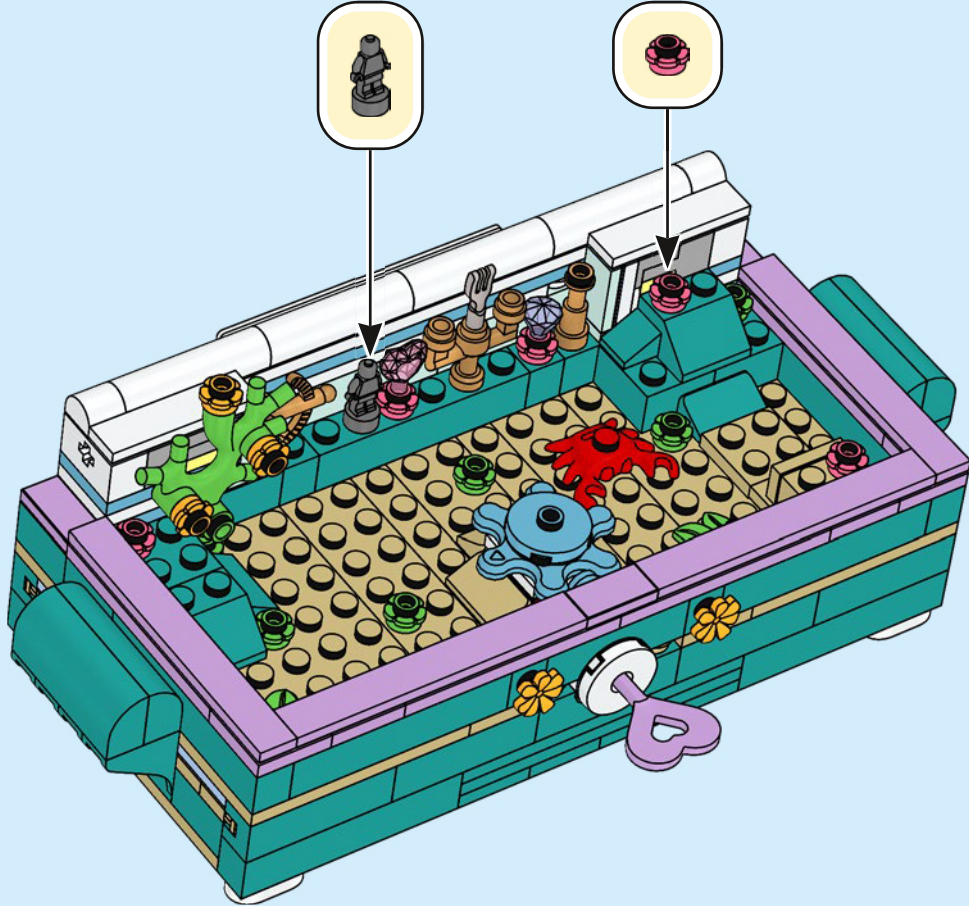



1x

67

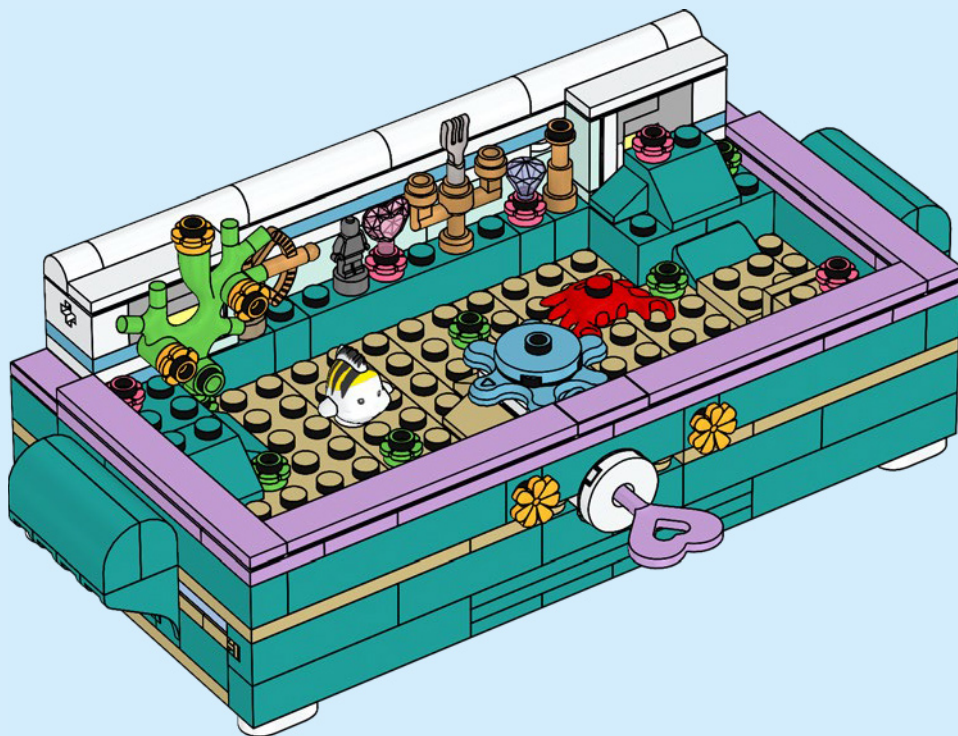

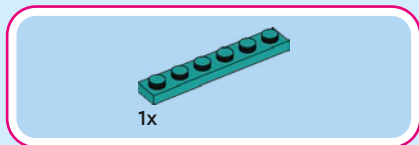
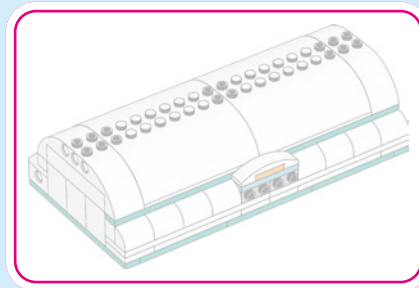

68

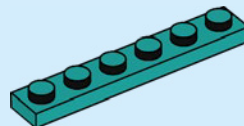



2x

69

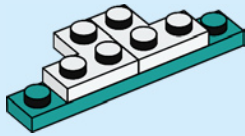

1x

70

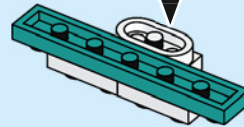

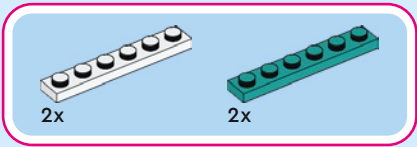

71

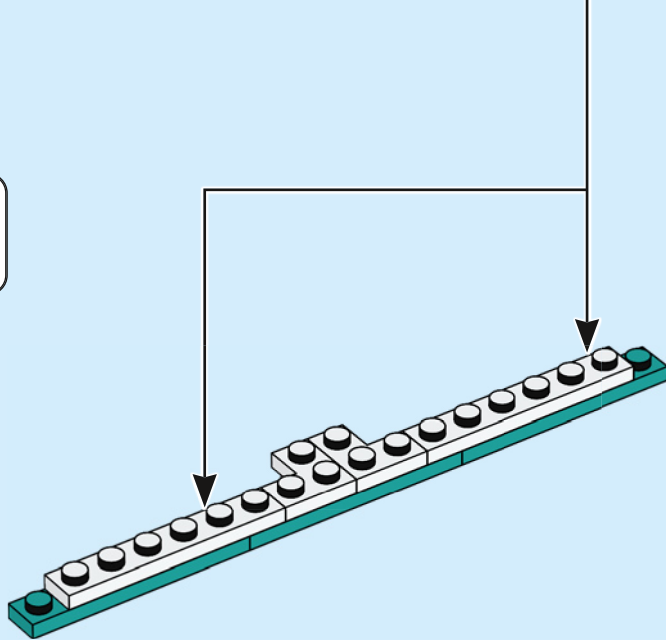
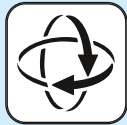
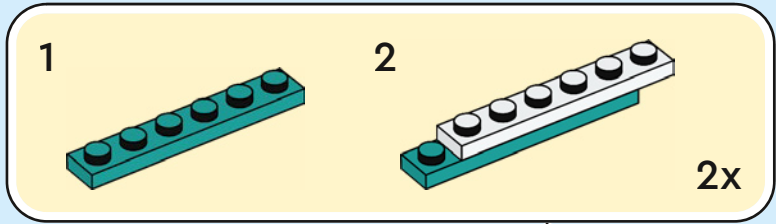



2x

72

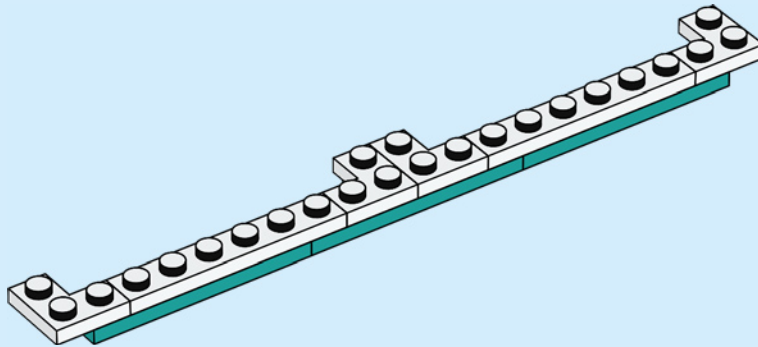

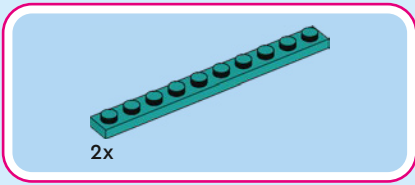

73

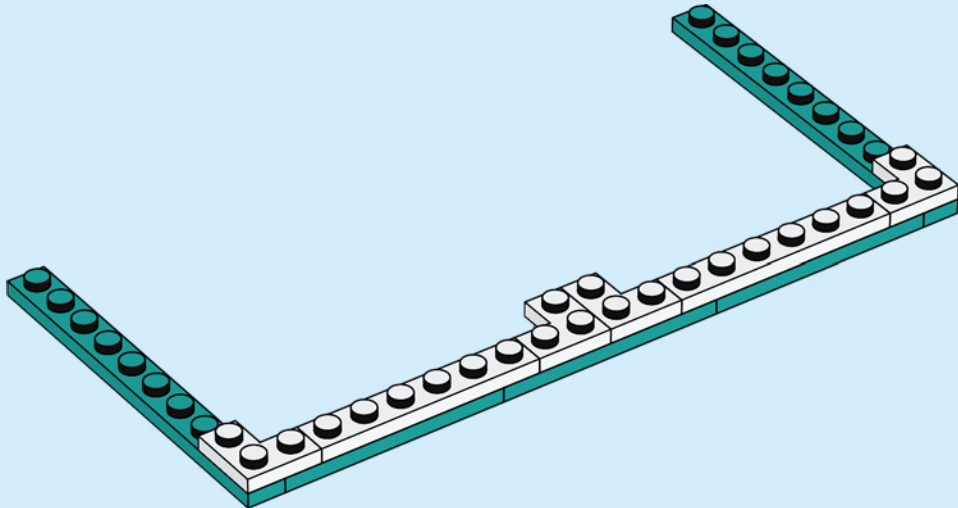

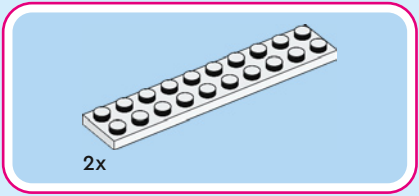

74

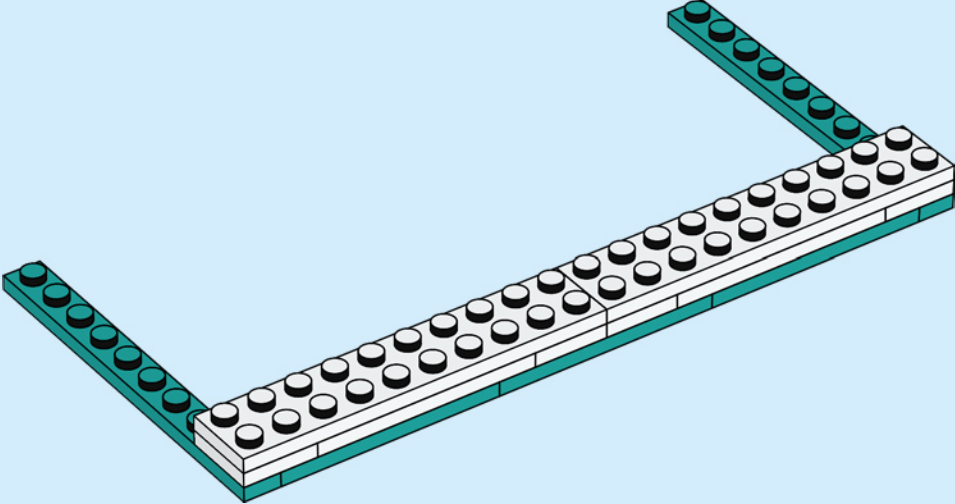

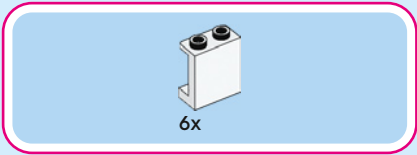

75

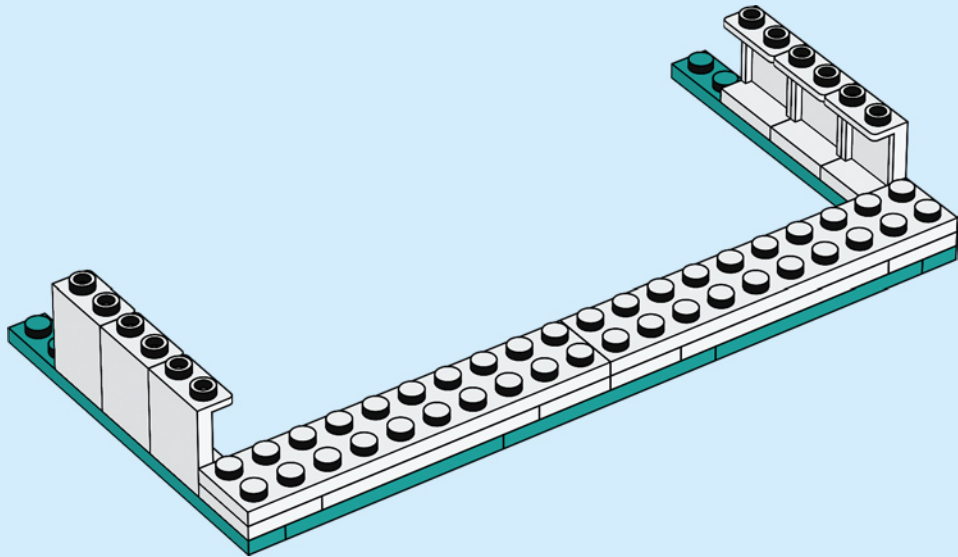

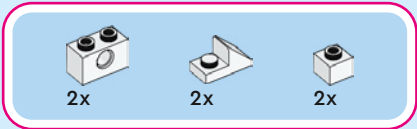

76

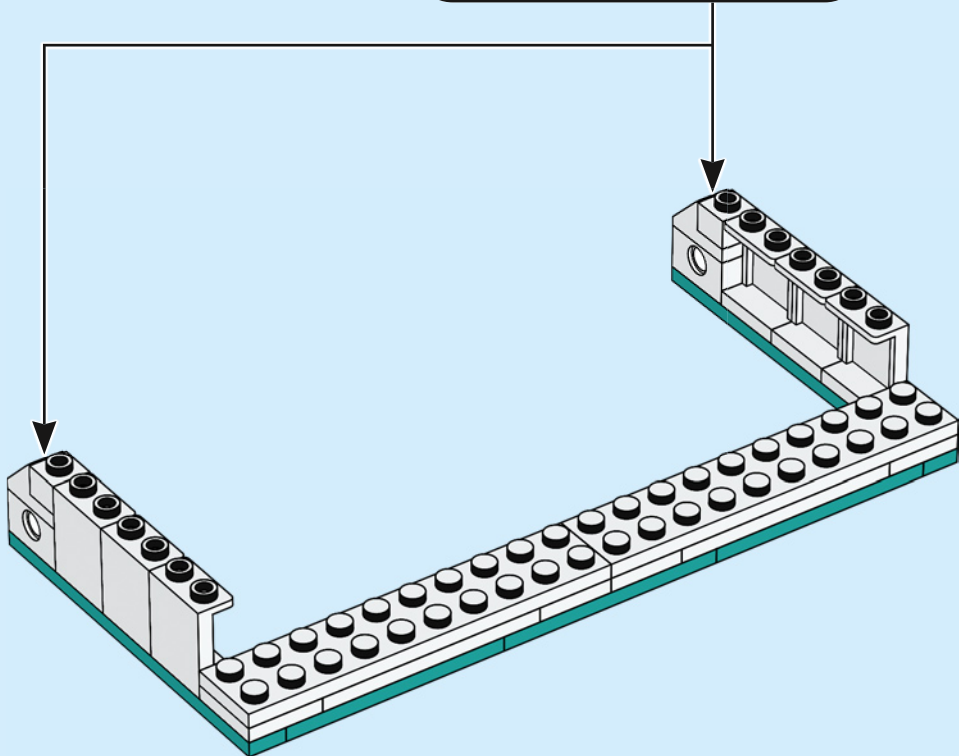
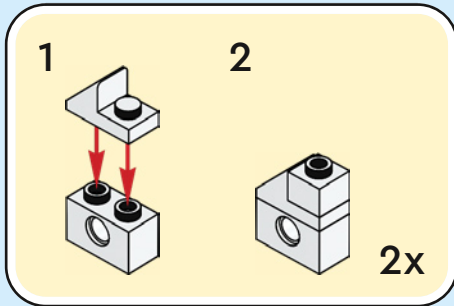

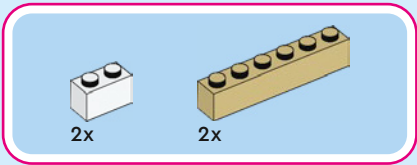

77

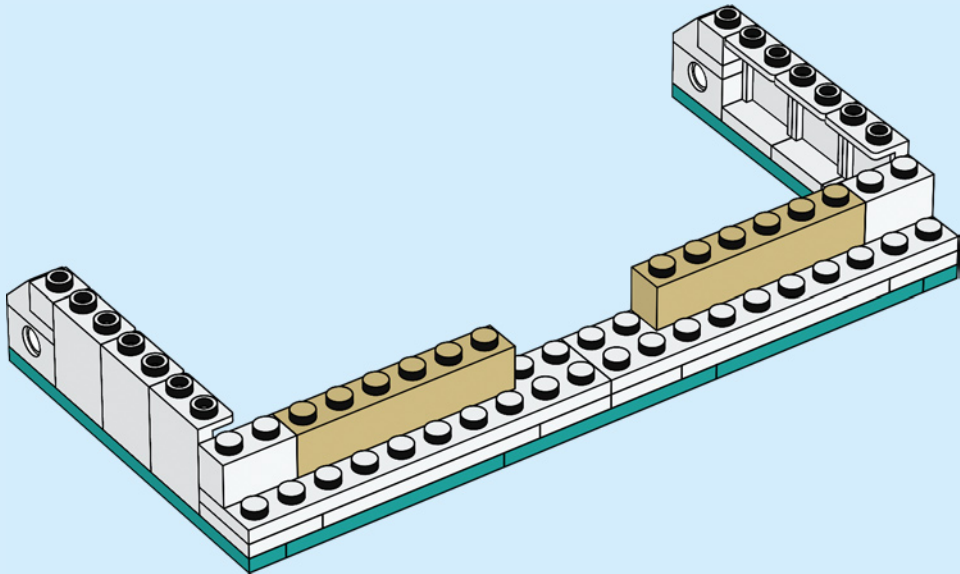

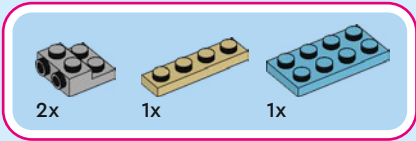

78

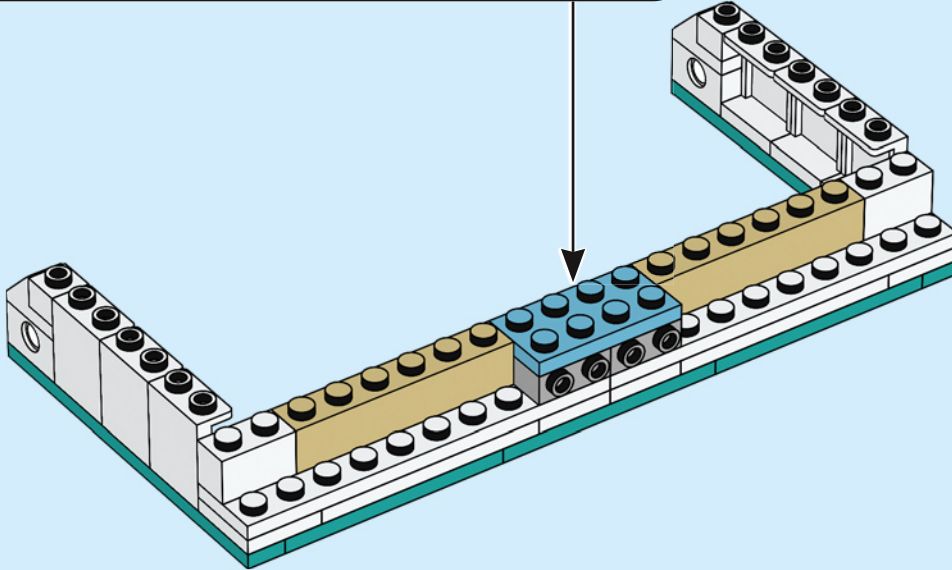
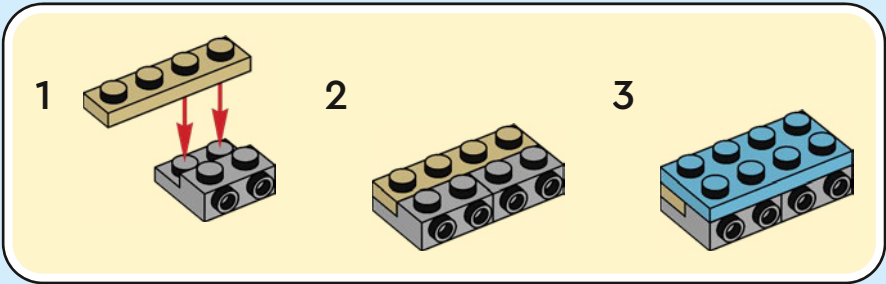



8x

79

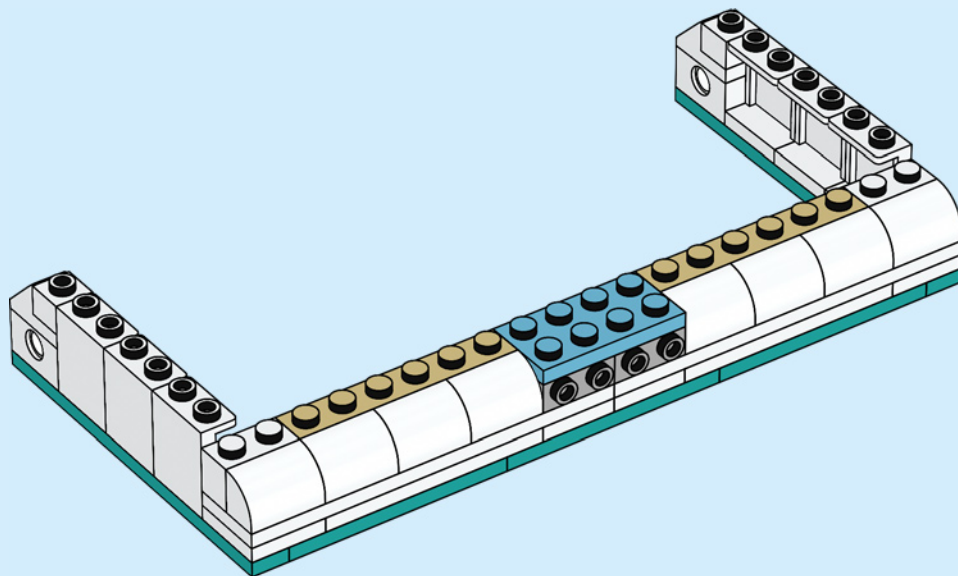

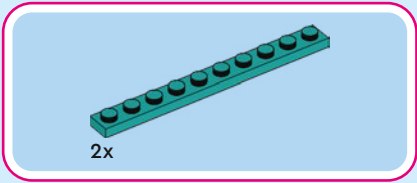

80

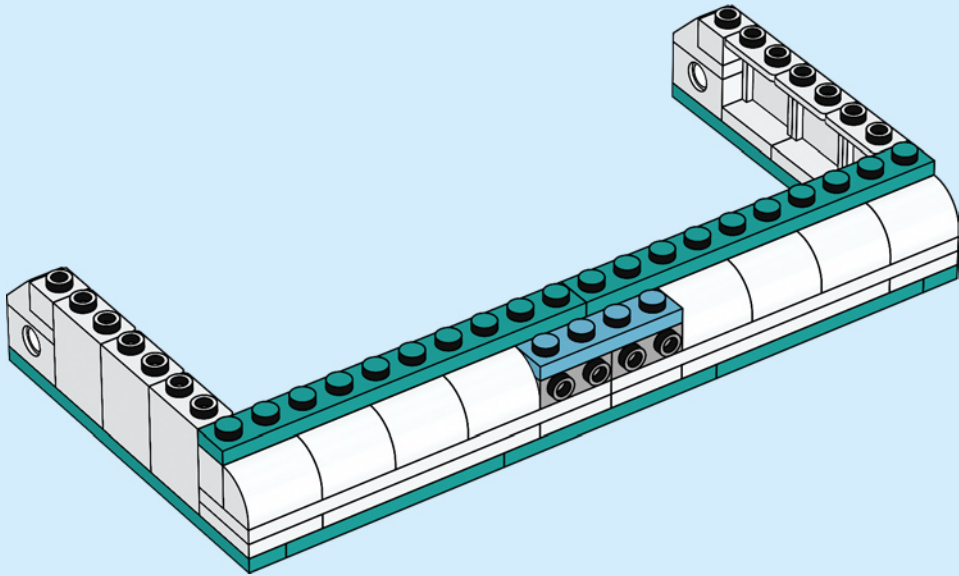

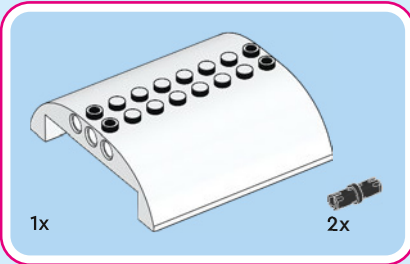
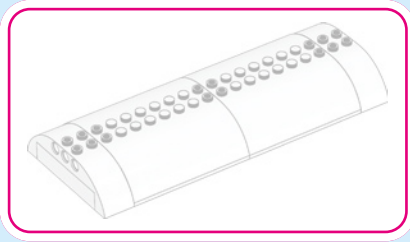

81

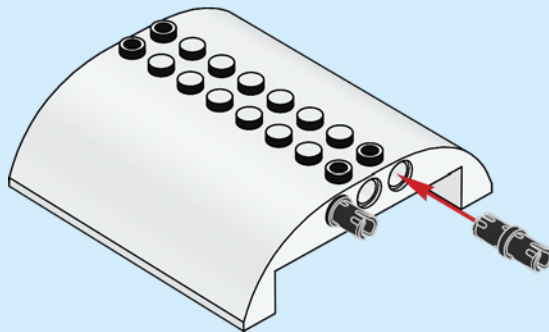

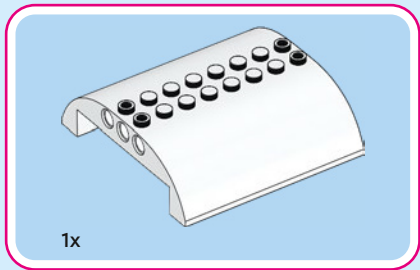

82

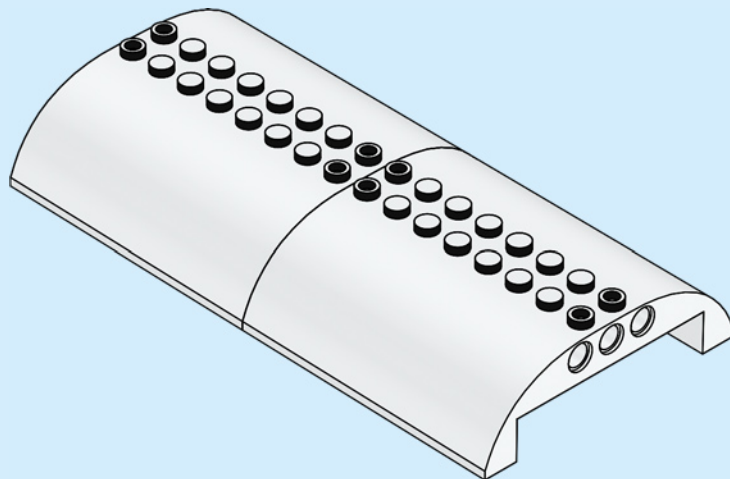

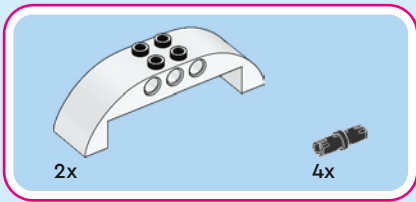

83

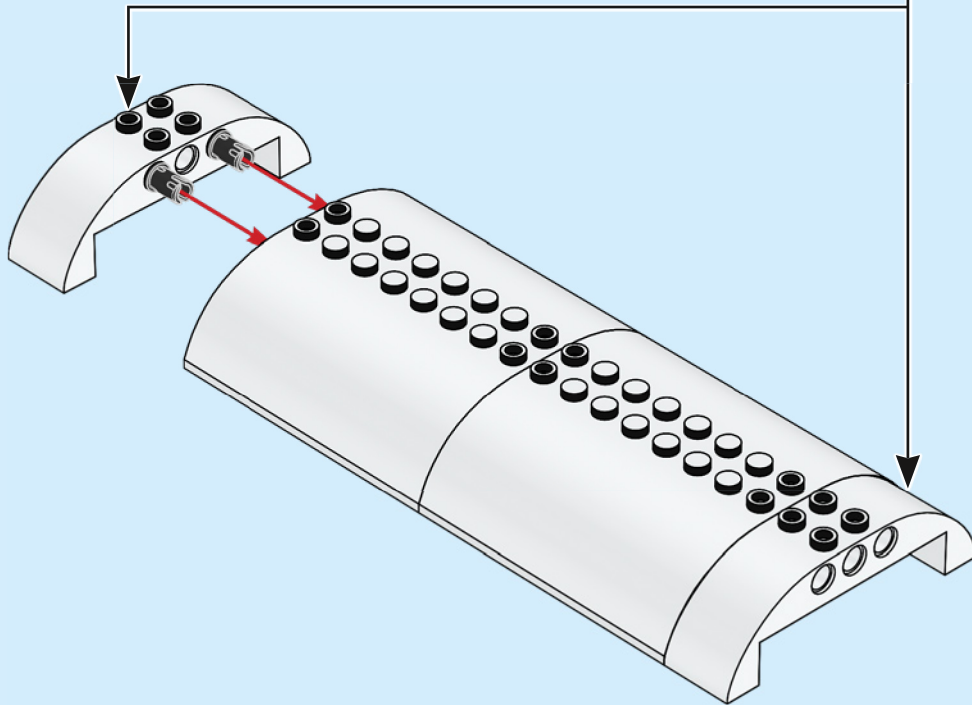
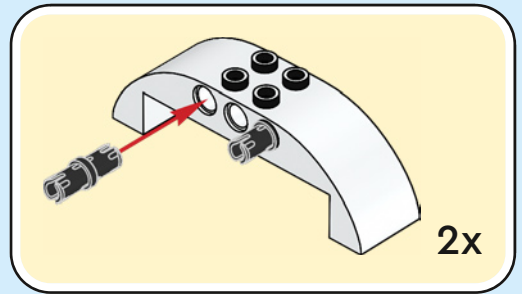



6x

84



6x

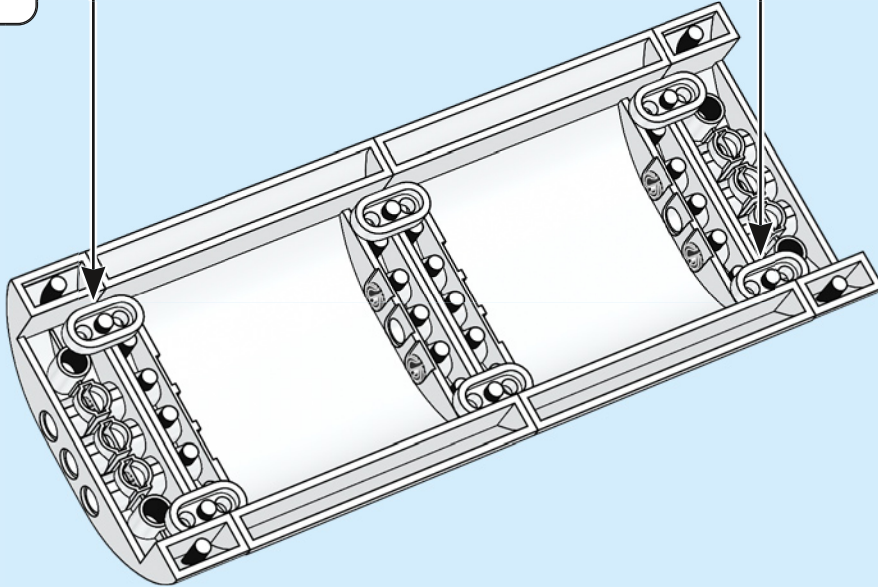

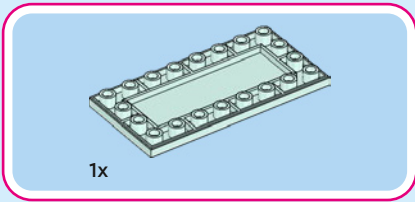

85

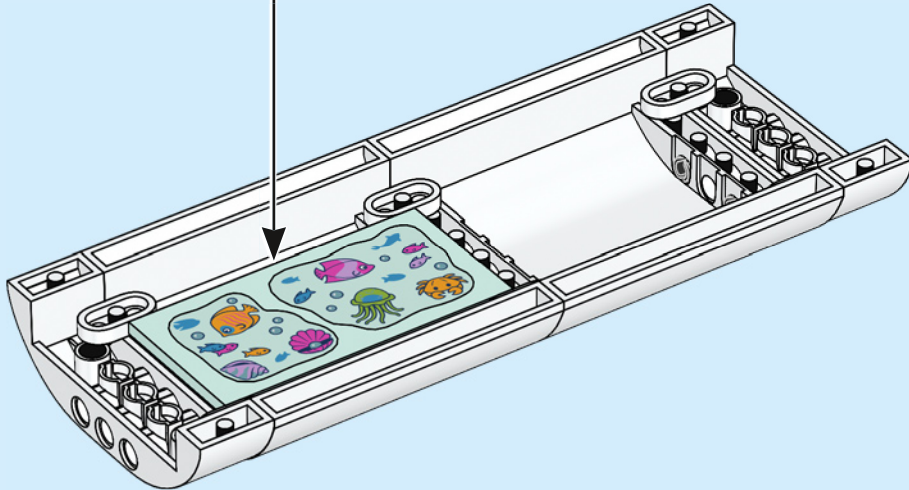
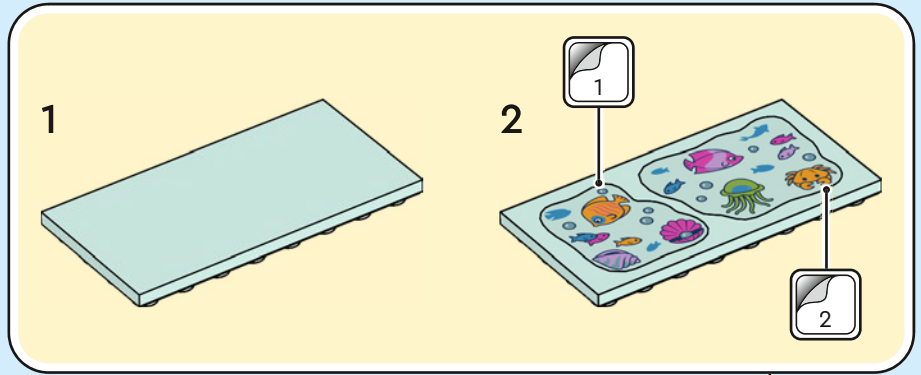

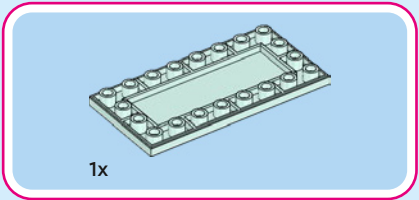

86

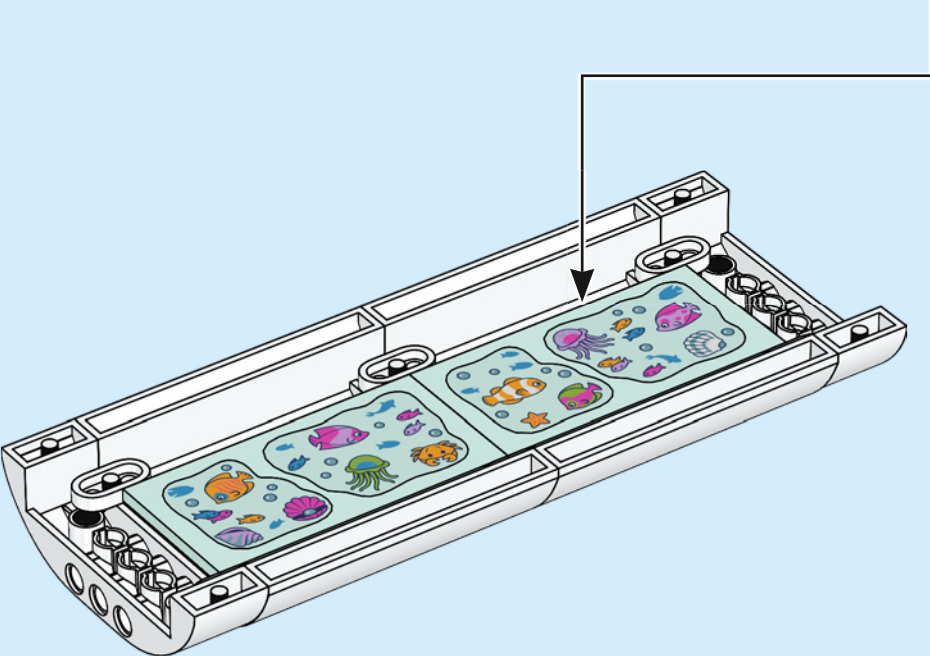
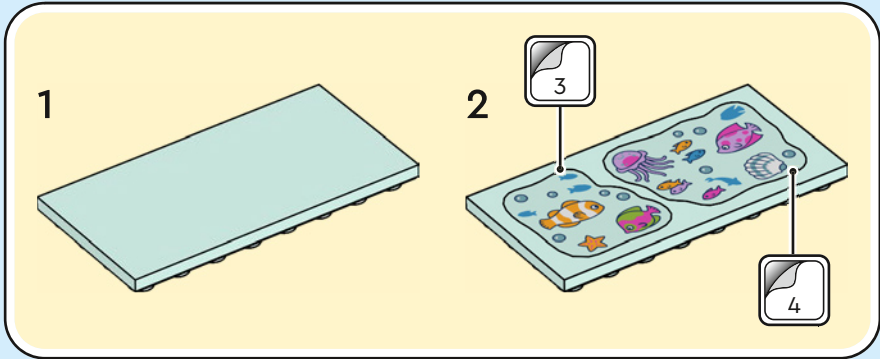

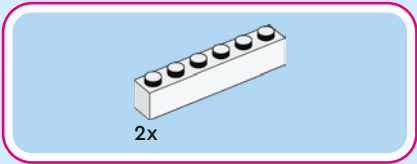

87

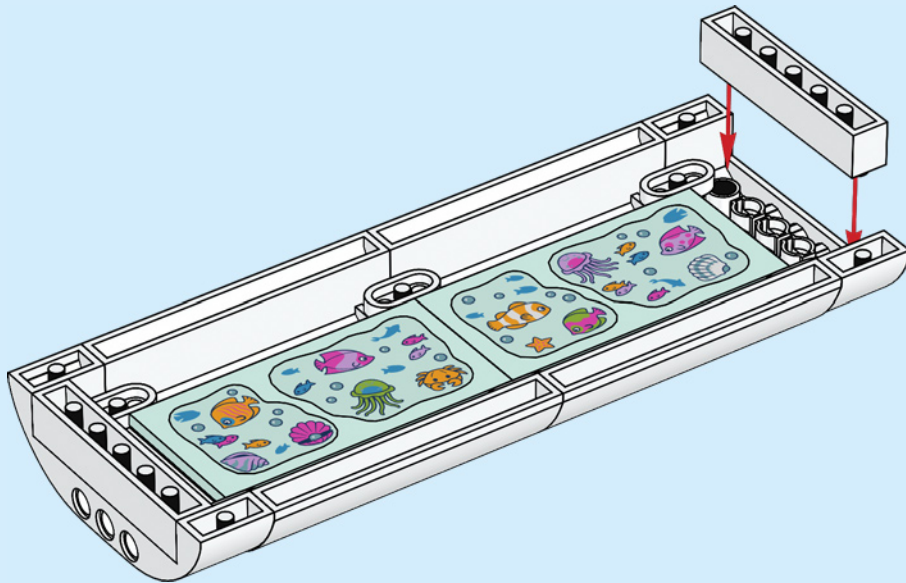

88

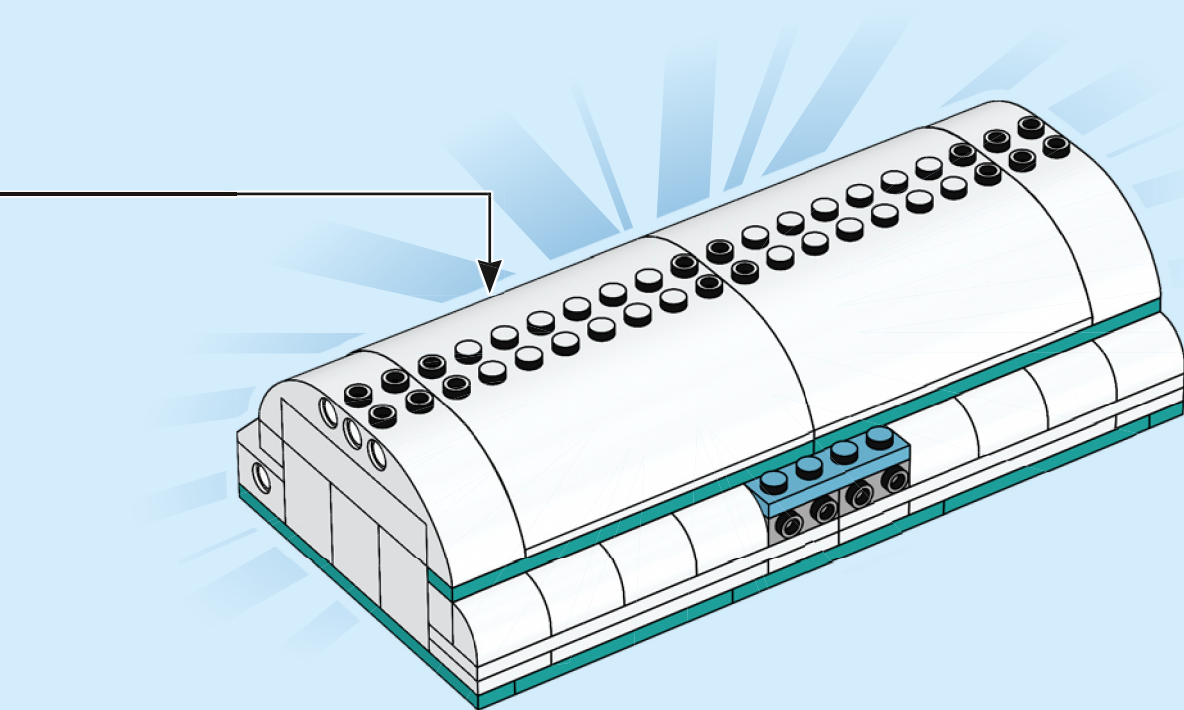



1x



1x

89

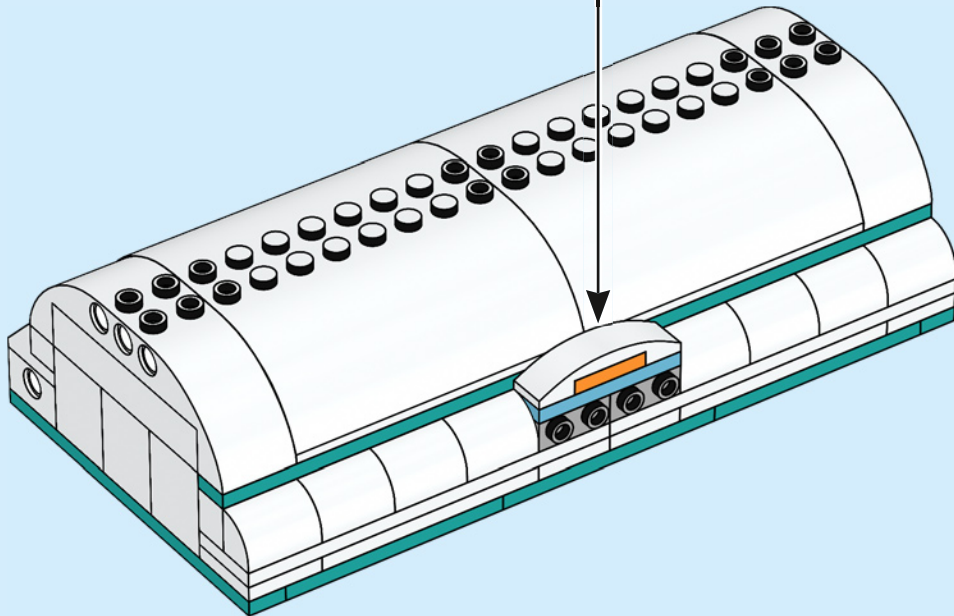
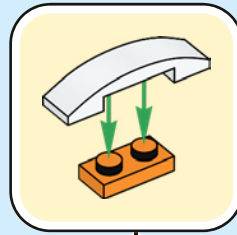

90

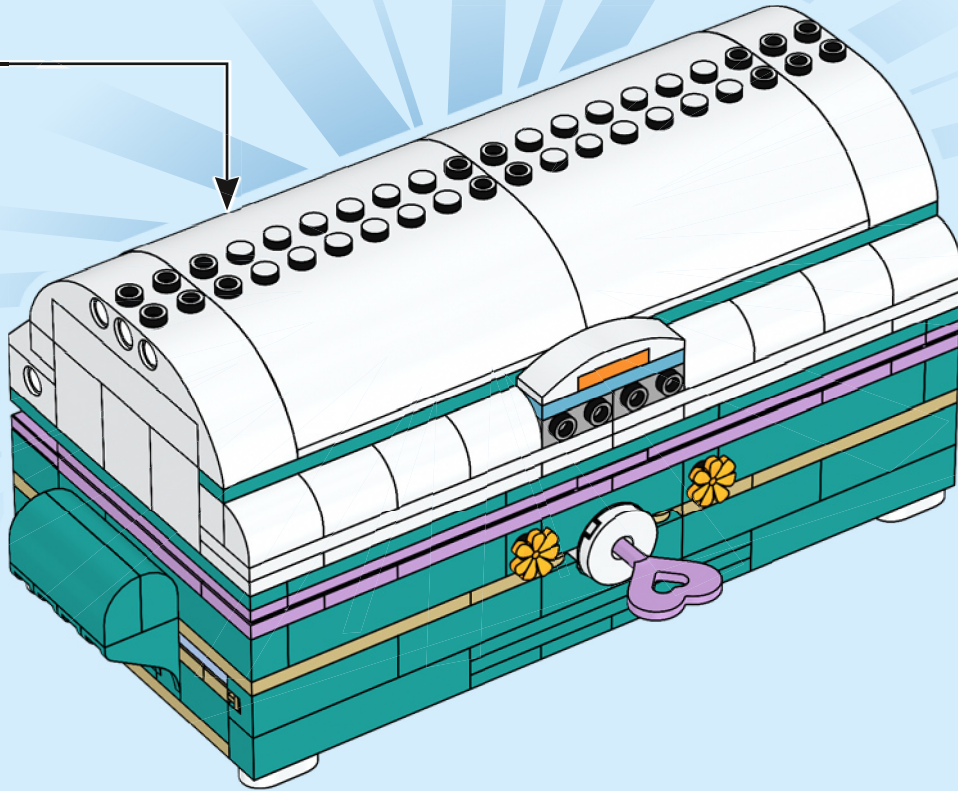

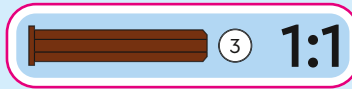
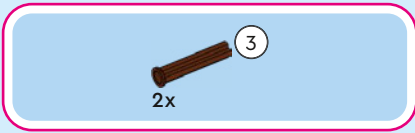

91

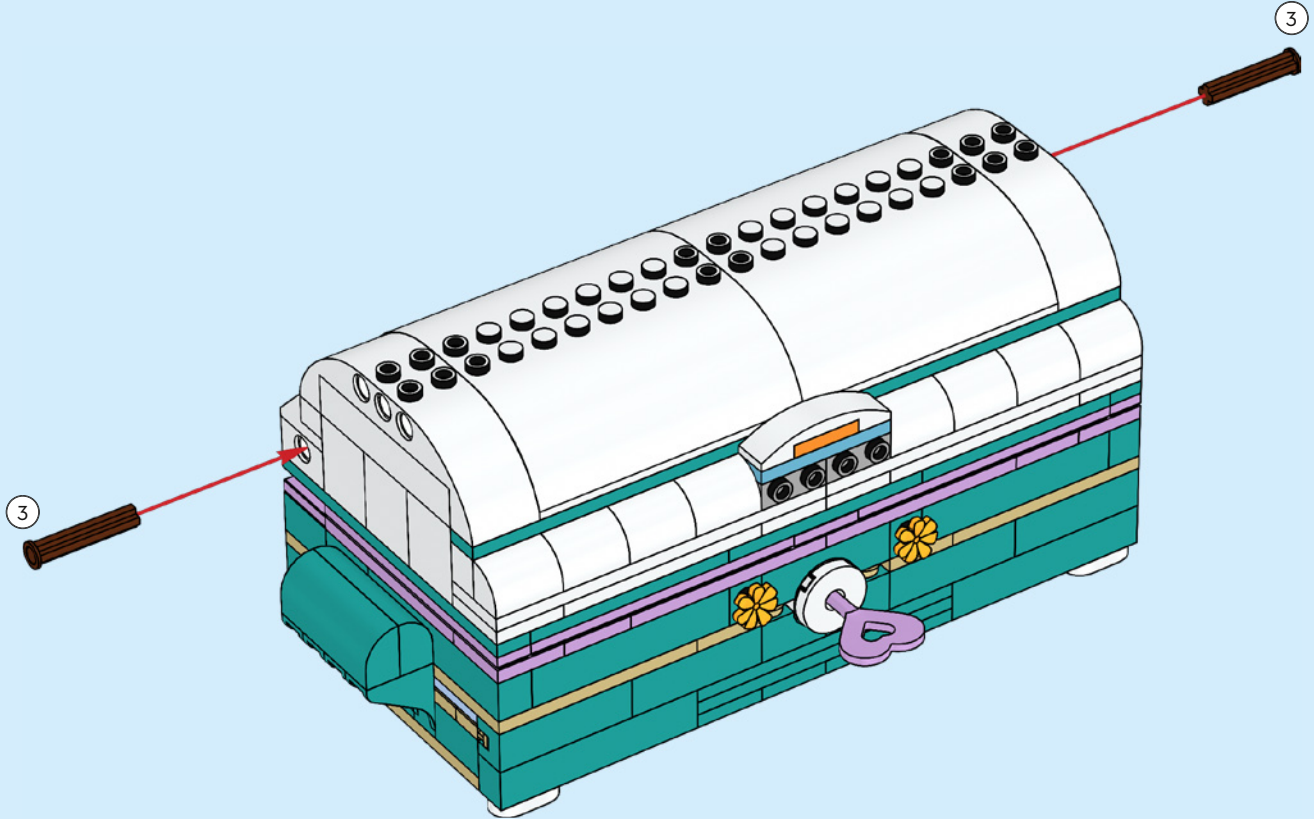

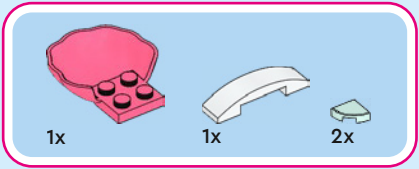

92

1



2



3



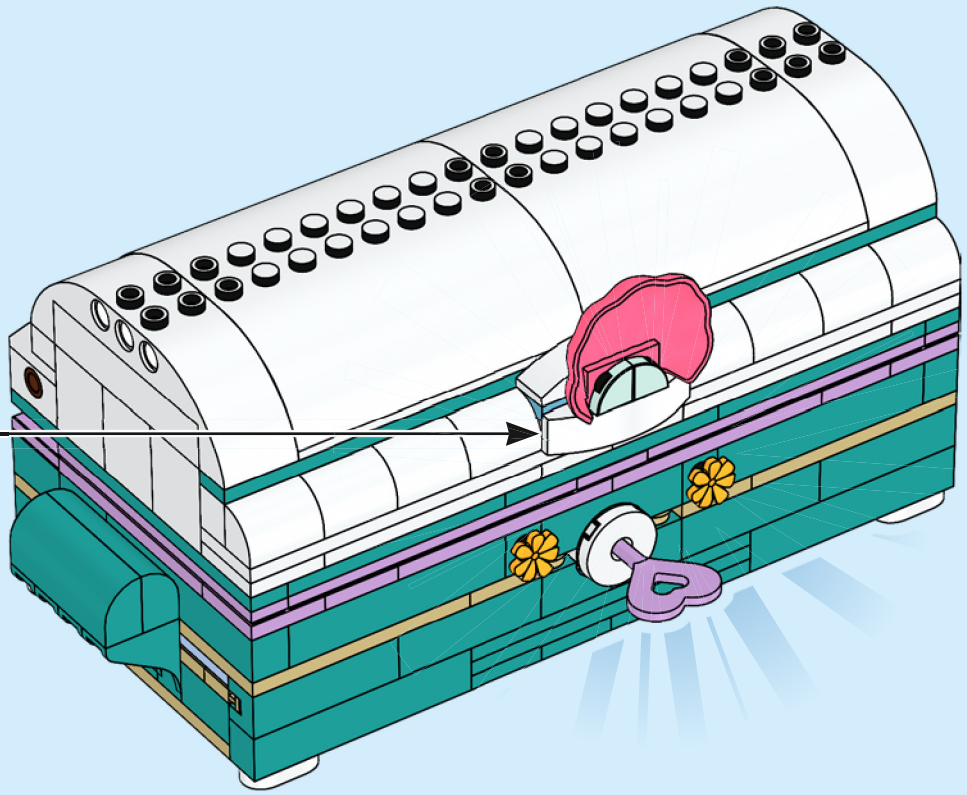

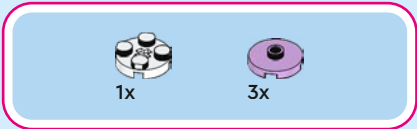

93

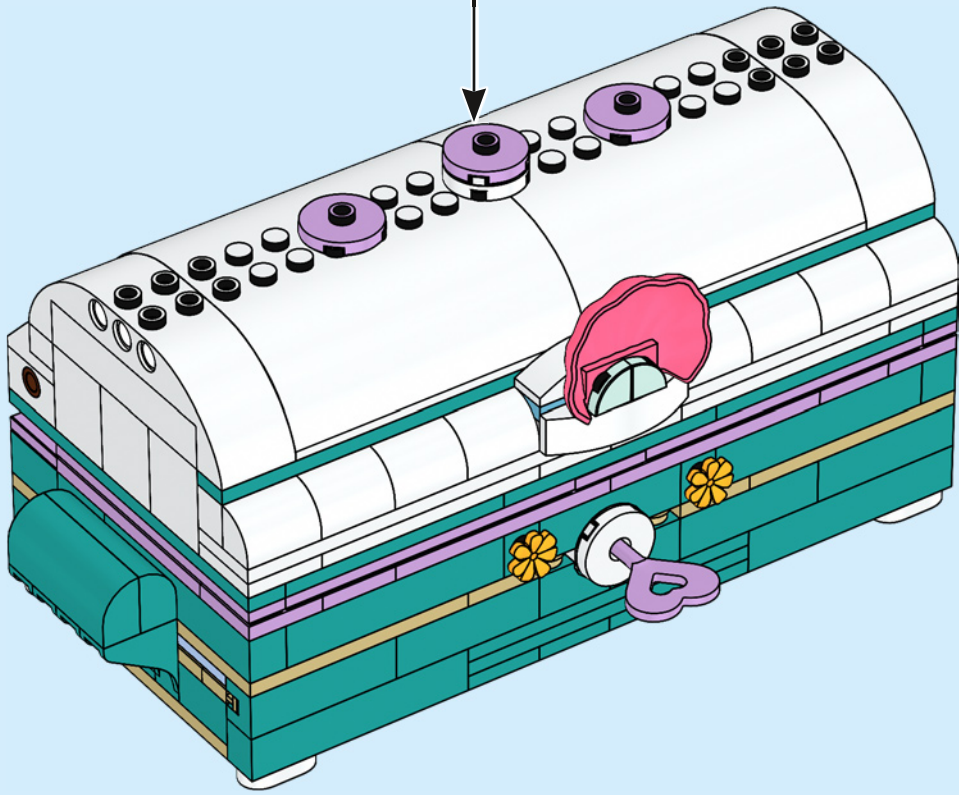
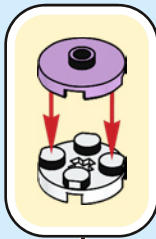



4x

94

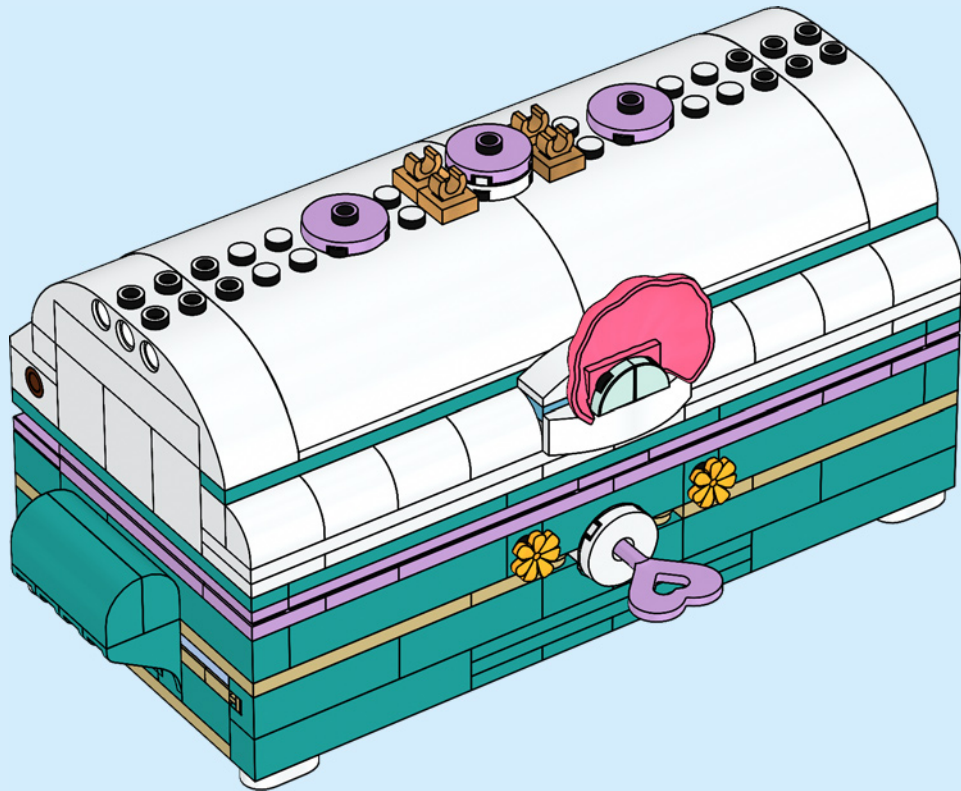



2x



4x

95

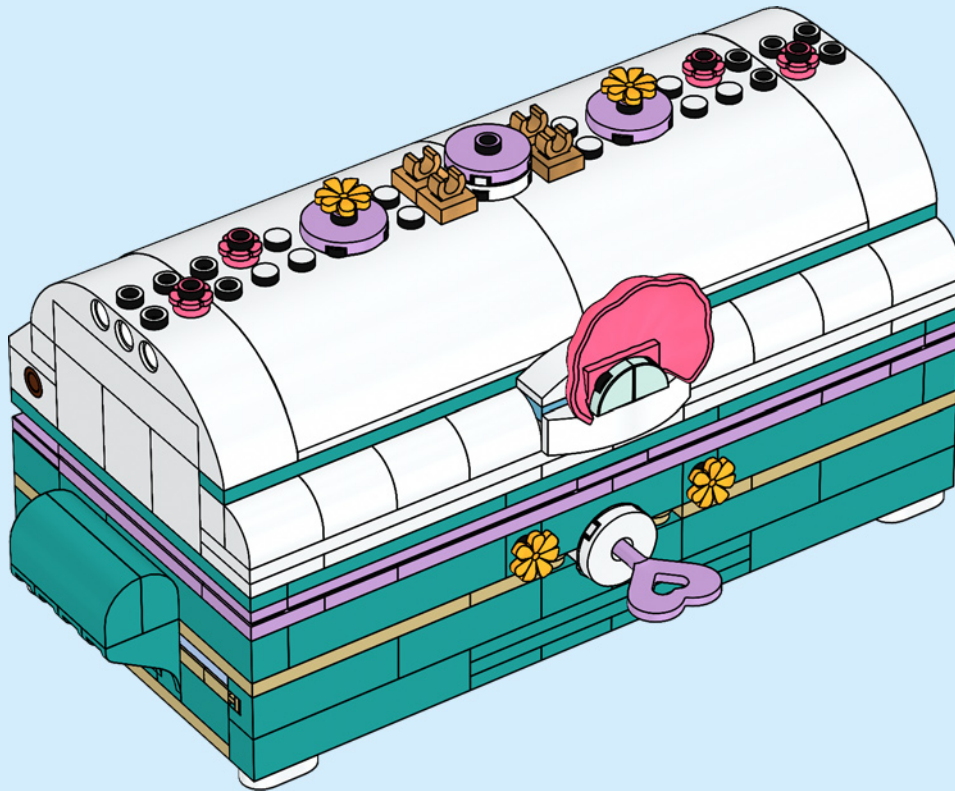



4x

96

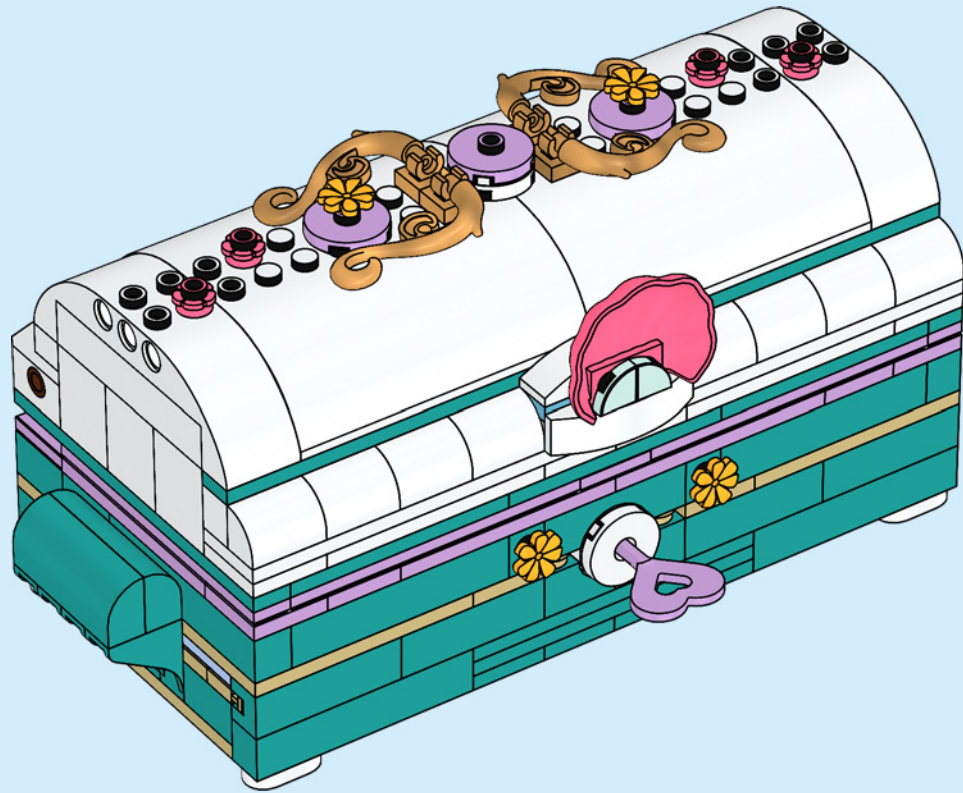

97

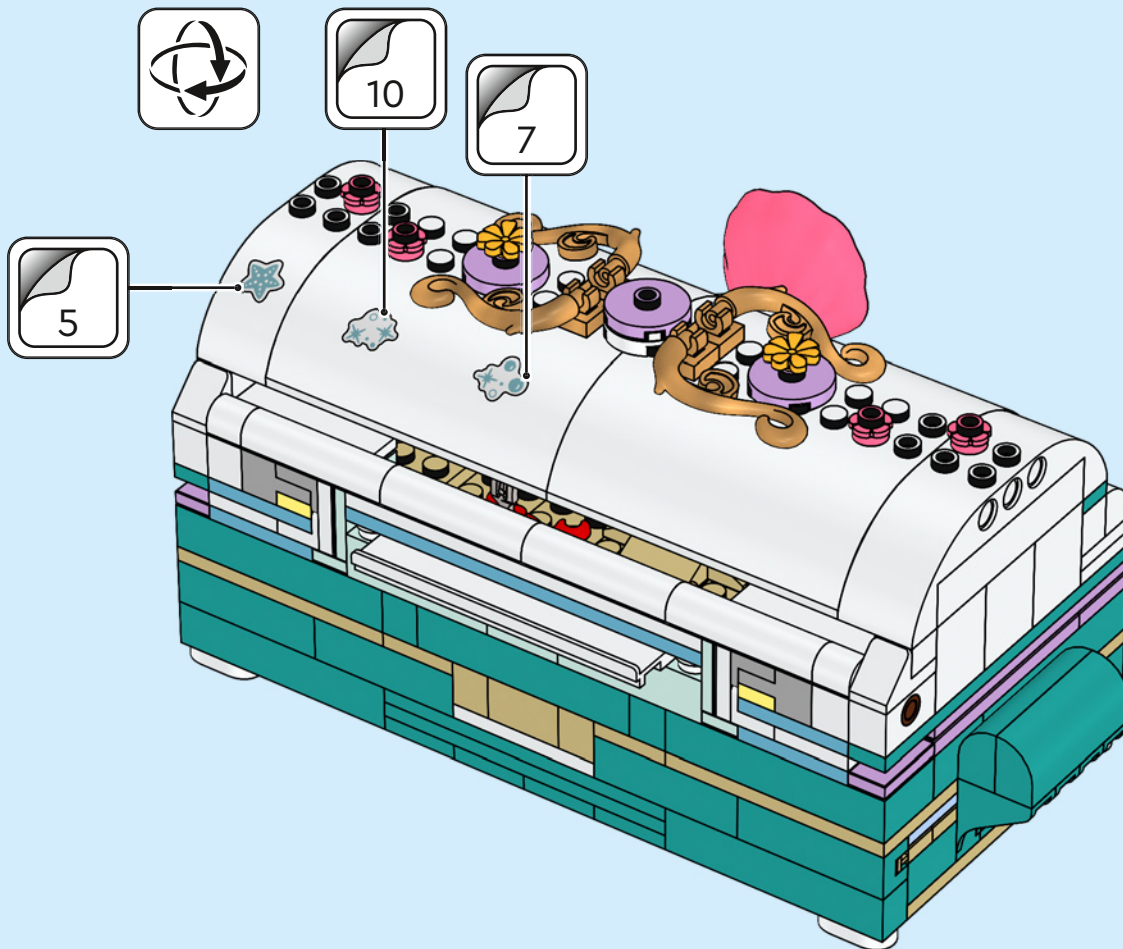

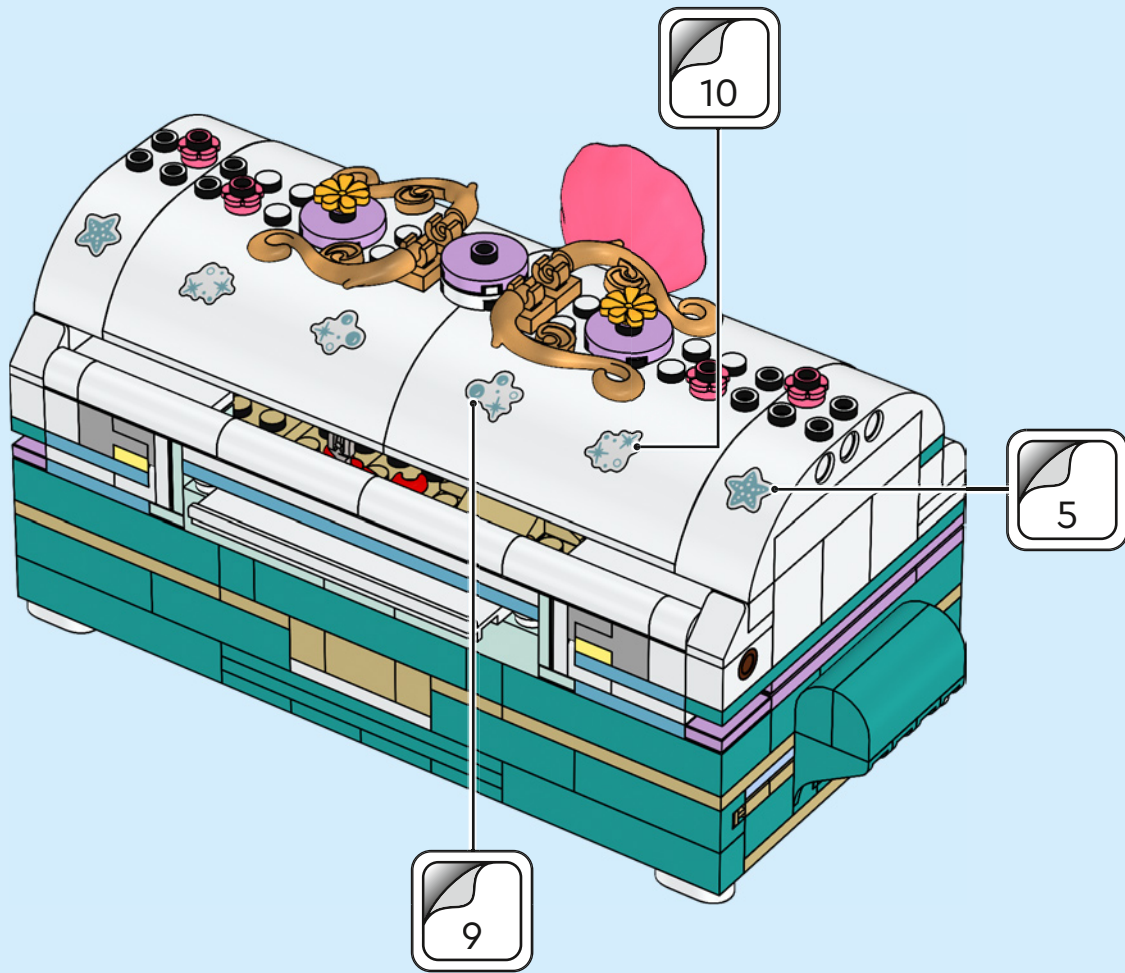

99

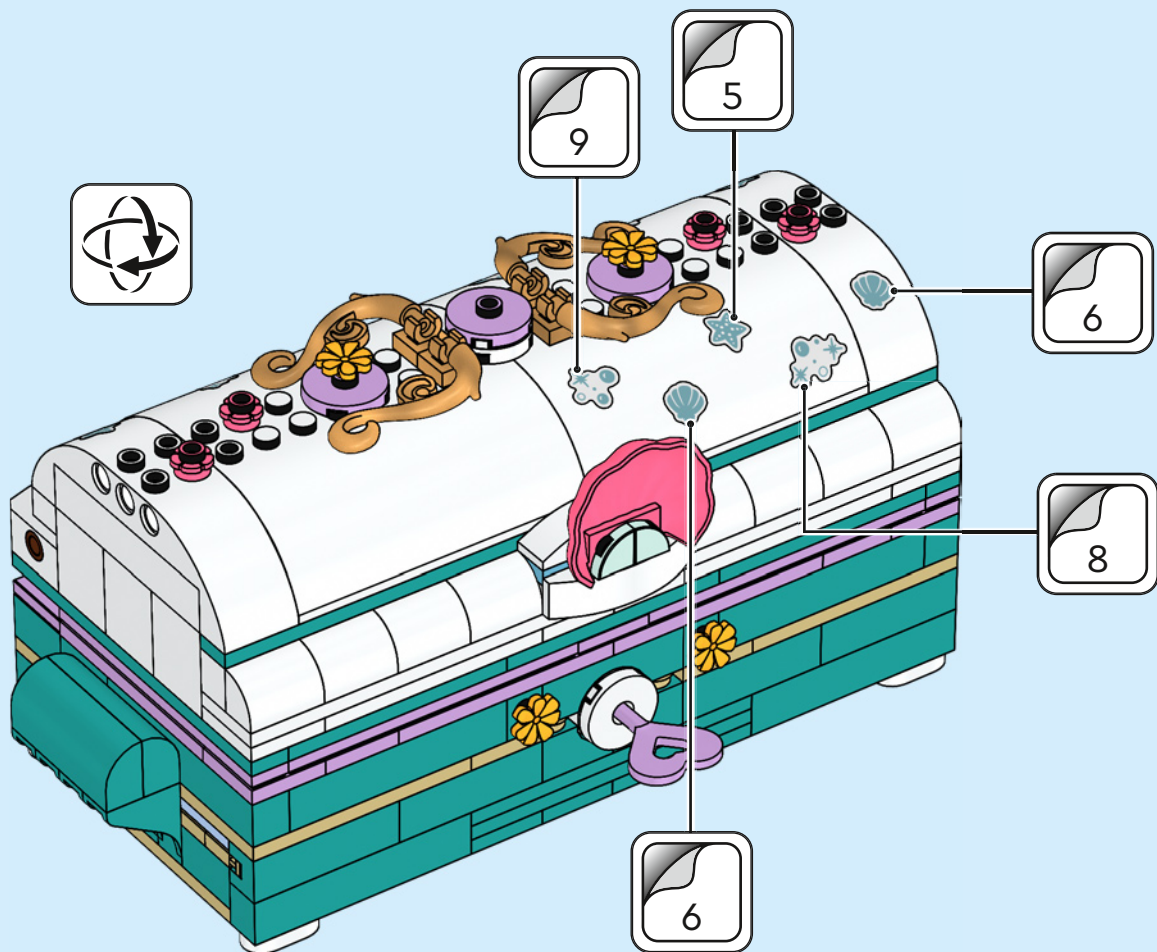

100

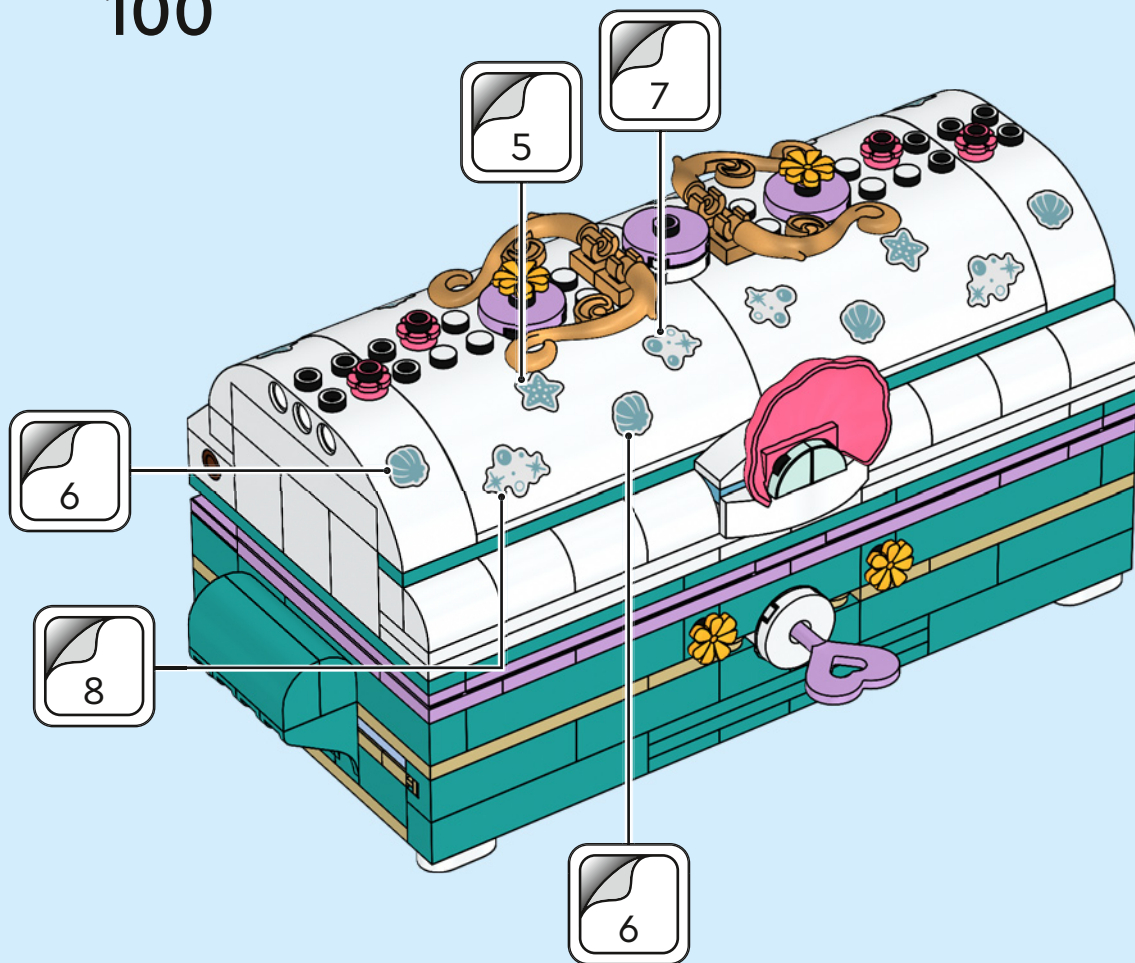

101

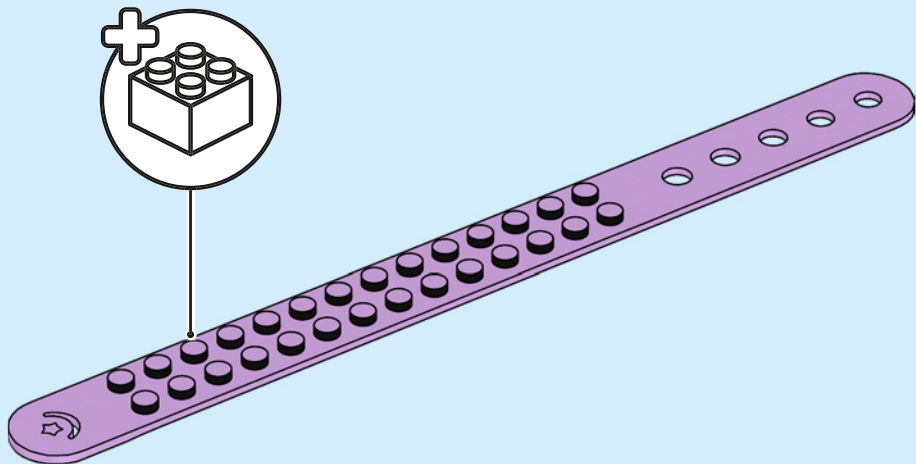

102

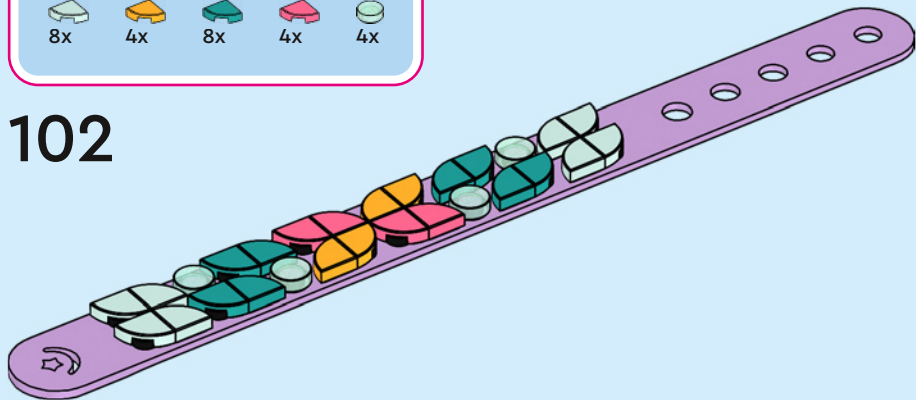



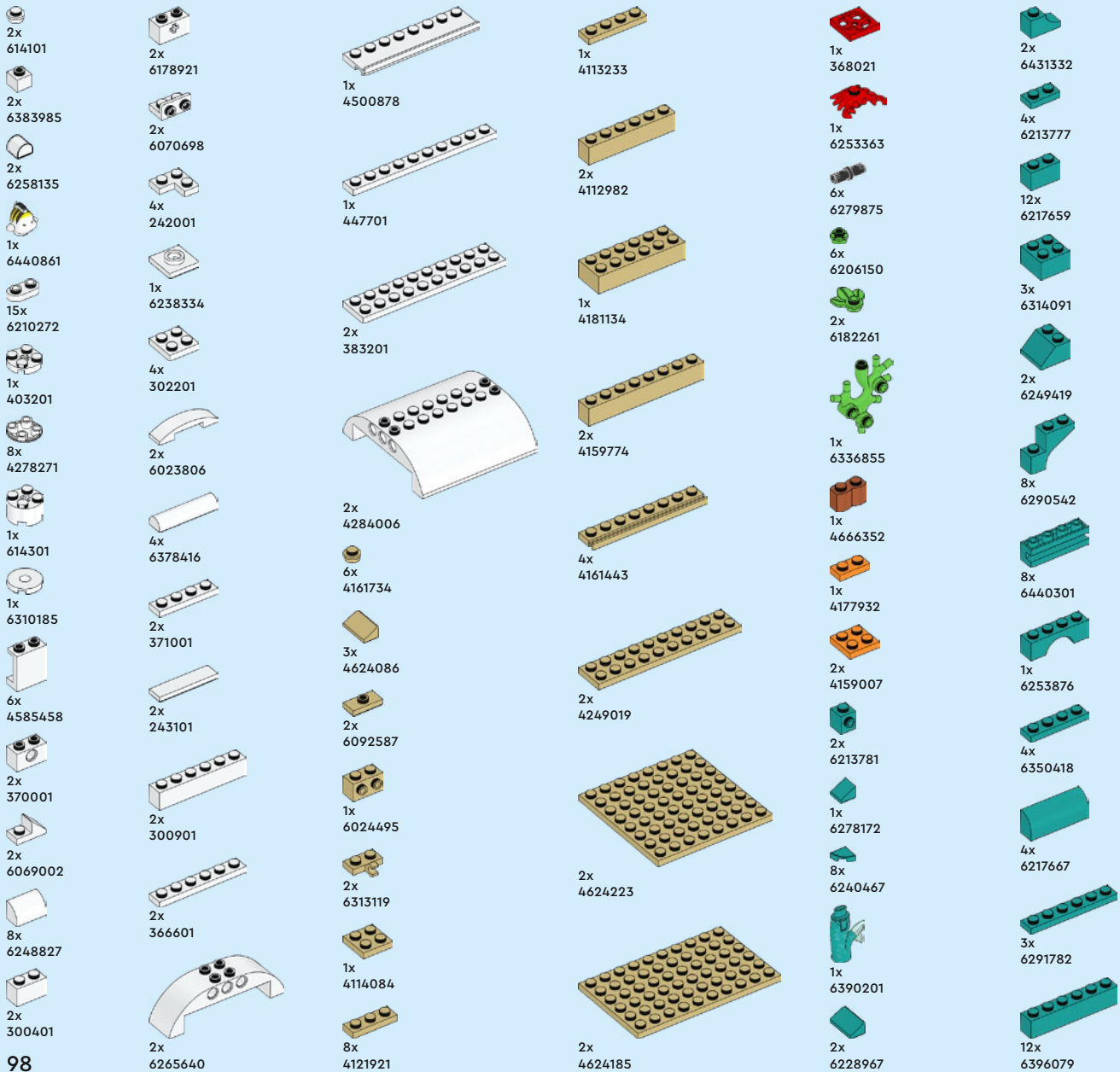

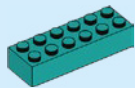

3x
6249420



4x
6259921



4x
6433414

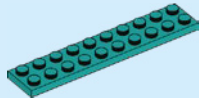

2x
6249538



1x
6240042



1x
6247799



1x
6300320



1x
6426063



3x
6209681



4x
6212994



4x
6214457



1x
6248944



2x
6135494



1x
4540203



2x
6266209



1x
6123809



2x
4654582



2x
6326478



2x
4654577



1x
6299494



8x
6372225

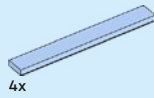

4x
6372121



1x
6096990



2x
6201647



4x
6262138



1x
6326425



1x
6323378



1x
4538126



1x
6147169



4x
6172437



1x
6422779



1x
6447710



1x
6361354



1x
6136419



4x
4619513



2x
6271207



1x
4655256



1x
6423273



10x
6199886



1x
6022032



2x
6133247



2x
6192270



2x
6218162



2x
6435048



11x
6295242



4x
6250022



1x
6287639



4x
6299900



1x
6376542



1x
6376535

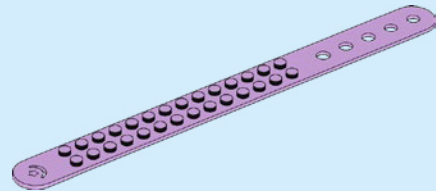

1x
6426229



1x
6385583



3x
6223598



2x
6099190



3x
6345796



2x
6400077



2x
6426723



4x
6204071



4x
6304891

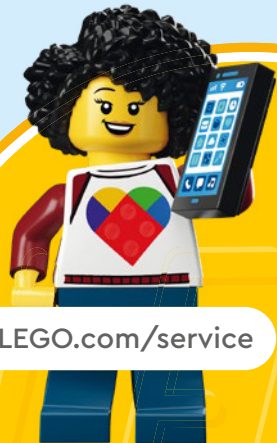

 [LEGO.com/service](https://www.LEGO.com/service)

YOU COULD **WIN**



Scan this QR code or go to
LEGO.COM/PRODUCTFEEDBACK and give us
your short feedback about this LEGO® set for a
chance to win a cool LEGO prize.

Terms and Conditions apply*

EN: YOU COULD WIN. Terms and Conditions apply* **DE: Du könntest GEWINNEN.** Es gelten die Teilnahmebedingungen* **FR: Tu pourrais GAGNER.** Des conditions s'appliquent* **IT: Potresti VINCERE tu.** Termini e condizioni sono applicabili* **ES: Puedes GANAR.** Aplican términos y condiciones* **PT: Poderá GANHAR.** Aplicam-se termos e condições* **ZH: 轻松获奖. 条款和条件适用*** **PL: Szansa na WYGRANĄ.** Obowiązują warunki korzystania* **CS: Máte šanci VYHRÁT.** Platí všeobecné smluvní podmínky* **SK: Máte šancu VYHRAŤ.** Platia všeobecné zmluvné podmienky* **HU: TE IS NYERHETSZ.** Felhasználási feltételek érvényesek* **RO: Ai putea CÂȘTIGA.** Se aplică termeni și condiții* **BG: Можете да СПЕЧЕЛИТЕ.** Има определени правила и условия* **LV: Tu vari LAIMĒT.** Ir spēkā noteikumi un nosacījumi.* **ET: Sul on võimalus VÕITA.** Kehtivad tingimused* **LT: Jūs galite LAIMĖTI.** Taikomos sąlygos*

*[LEGO.com/productfeedback-terms](https://www.lego.com/productfeedback-terms)